



# Radio-Craft

for the  
Professional-Serviceman-Radiotrician

Dec  
25 Cents

HUGO GERNSBACK Editor

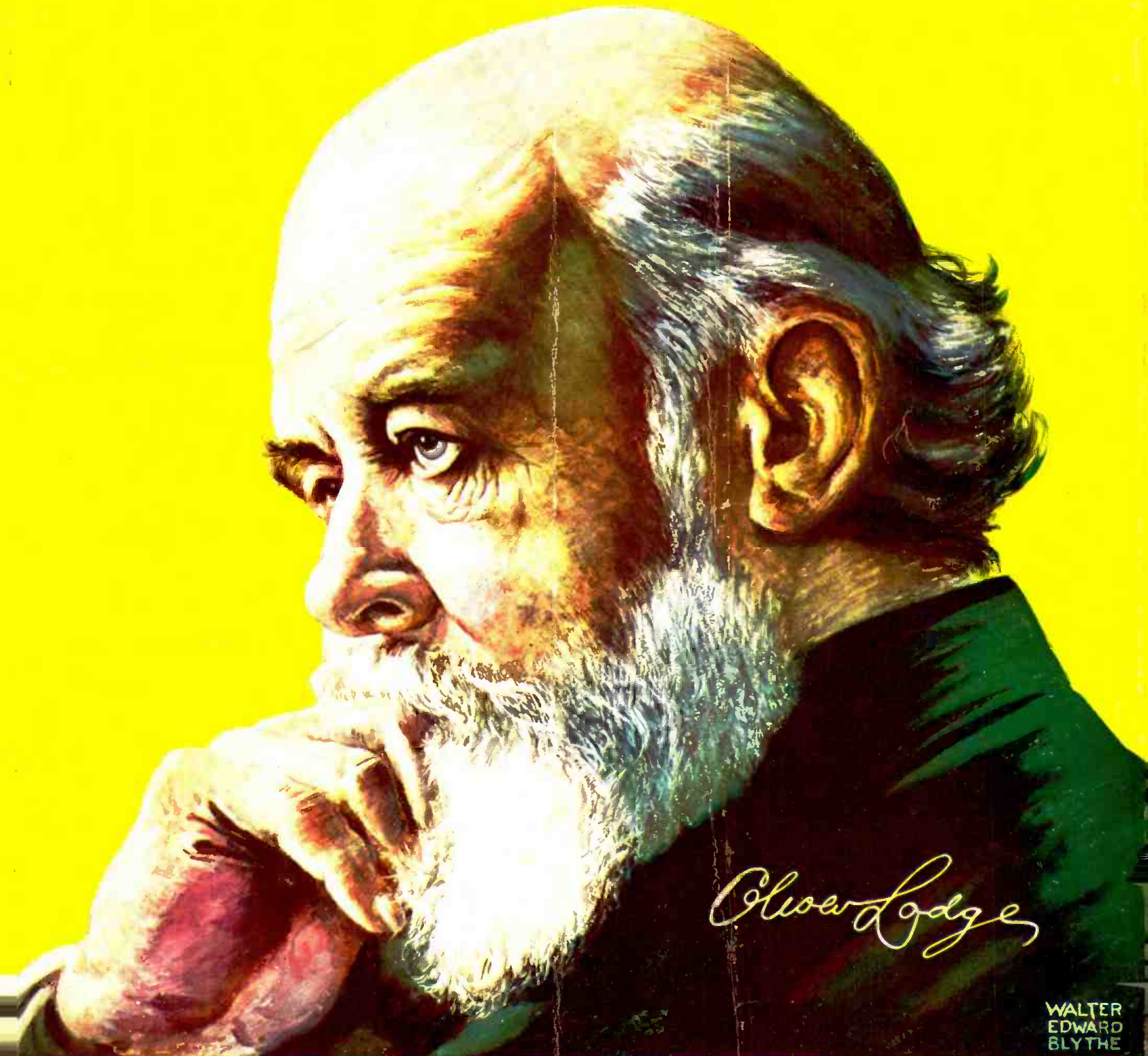

WALTER  
EDWARD  
BLYTHE

**Men who have made Radio: Sir Oliver Lodge**

# WHAT'S NEWS IN RADIO ?



## PILOT Power Packs

No. K-111 for \$16.50  
171-A Tubes

Thorough filtration of direct current output, makes hum inaudible. Self-contained rectifier tube. Highly compact. Delivers up to 220 volts. Complete, ready for use. Especially recommended for the A.C. Super-Wasp.

No. K-112 \$19.50  
for 245 Tubes

Easily handles two 245's in push-pull plus five or six 227 and 224 types. Variable resistance insures delivery of full rated voltages from the various taps. Delivers up to 300 volts. Ultra-compact. Complete, ready for use.



## PILOT Push-Pull AMPLIFIER

[For 245 Tubes]

Here's an amplifier big enough and powerful enough for movie "Talkies" and public address systems. Wherever requirements demand maximum amplification, free from any hint of distortion, this Pilot outfit is recommended. All A, B and C voltages self-contained. Complete in semi-kit form (K-113).

**\$39**

## A. C. SHORT-WAVE RADIO



## PILOT SUPER-WASP

Kit K-115 **\$34.50** Power Pack Extra

Hear dozens of stations you never knew existed . . . short-wave broadcasts from foreign countries . . . strange music . . . surprises by the score . . . the thrill of trans-oceanic reception is now yours, plus the convenience of A.C. operation.

Special Note—The Battery-Operated Super-Wasp, Kit K-110, will continue to be available. Custom Set-Builders' Price **\$29.50**

## OUTSTANDING FEATURES

- 1—Complete kit—can be assembled in a single evening!
  - 2—Employs the specially developed Pilotron 227—the only A.C. tube suitable for short-wave detection!
  - 3—Utilizes super-sensitive screen grid tube.
  - 4—Tunes from 14 to 500 meters.
  - 5—Operates from any ABC power pack of proper type.
- (Pilot K-111 is recommended, \$16.50)



## PILOTIONS

Endorsed by Professionals

The original idea behind the Pilotrons was to make a line of radio tubes for a select group of professional radio engineers, custom set-builders, radio researchers, and others whose standards are considerably higher than the general public's. To win endorsement from radio's fussiest folks, Pilotrons had to be outstandingly superior! The constantly mounting demand for Pilotrons required the purchase of an additional tube factory. . . . Now, the general public, learning from radio technicians, insists on Pilotrons, endorsed by professionals.

## RADIO'S BIGGEST VALUE 50¢

brings you membership in Radio International Guild, including the official organ, *Radio Design*—a construction quarterly that sparkles with the latest and greatest radio and short-wave developments! Current issue, together with Membership Pin, Card and Certificate, will be promptly sent on receipt of remittance.

RADIO DESIGN PUB. CO.  
Dept. 101, 103 Bway, Bklyn, N.Y.

Prices Quoted are for Custom Set-Builders in U. S. A.

Get Pilot's Latest Catalogue from nearest authorized Pilot Dealer or write Direct to Factory.

# PILOT RADIO & TUBE CORP.

WORLD'S LARGEST RADIO PARTS PLANT—ESTABLISHED 1908

323 BERRY STREET

BROOKLYN, NEW YORK



8:15—Musica.  
 8:30—The Daily  
 8:45—Ocean Revue.  
 9:00—Morning Devotions  
 9:15—Something For E.  
 9:30—Kobomoku's  
 12:15—National  
 12:30—Matinee  
 1:00—Dr. Frank  
 1:15—Melody Market  
 1:30—Stock Market  
 1:45—Sunshine  
 2:00—Ball Scores  
 2:15—Correct Time

# Everything in RADIO! at *Lowest* WHOLESALE PRICES



## Get this... CATALOG

This big book of 148-pages—rich from cover to cover with radio bargains—is yours for the asking. It contains all the latest radio devices and improvements—sets, accessories, parts and kits—profusely illustrated. No radio need is overlooked. Everything in this big book is available at wholesale prices, and many items are spotlighted as Specials at truly astounding reductions. To be without this book is to miss your greatest buying opportunity in radio. Every page points the way to money-saving. Never before have such startling values been offered—made possible by our tremendous buying power and low cost of operation. Quick deliveries and expert cooperation assured to all our clients. A trial order will make you a regular customer, just as it has thousands of our pleased customers.

*Clip the Catalog Coupon, and mail it today!*

### *New* SCREEN-GRID Models

Marvelous offerings in new, Humless, Screen Grid A. C. all-electric and battery operated sets; a wide range of beautiful consoles, from the small table model types to the most ornate and artistic of radio furniture; dynamic speakers of tremendous volume and richest tone; accessories, parts and kits in wide variety—in fact, everything that is standard, as well as everything that is new, in Radio. Get this book today!

### *Price-Saving* COUPON

Chicago Salvage Stock Store  
Dept. 130  
509 So. State St., Chicago, Ill.  
Kindly send me (free of charge and postpaid)  
your new 148-page Book of Radio Bargains.

Name.....  
Address.....  
City..... State.....

**CHICAGO SALVAGE STOCK STORE**  
World's Largest Radio Store  
509 So. State St. Dept. 130 Chicago, Ill.

H. GERNSBACK, President  
S. GERNSBACK, Treasurer  
J. M. HERZBERG, Vice-President  
I. S. MANHEIMER, Secretary



VOLUME 1  
NUMBER 6

R. D. WASHBURNE,  
Technical Editor

C. P. MASON,  
Associate Editor

HUGO GERNSBACK, Editor-in-Chief

### Money in Automobile Radio

By HUGO GERNSBACK

ONE of the important new developments in radio that has come about lately is the automobile radio set. From a purely experimental stage, the car set has now been developed to such a stage that, during the next few years, a tremendous new outlet for radio sets and radio parts will have been created. And, incidentally, those who get in on the ground floor will, as usual, reap a rich harvest.

\* \* \* \* \*

AN important point to be remembered, not only by radio enthusiasts but by the entire radio trade as well—is that the radio car set is an ADDITION to the natural consumption of radio sets; for the simple reason that the man who owns a radio at home cannot take that set and install it into his car. It means an entirely new, as well as a different set. Of late, the car set has taken the public's fancy; and several large manufacturers have announced their intention to equip their cars regularly with such sets for the coming season. Foremost among them is the Dodge Company.

A radio set in a car today is a necessity, because it enables one to keep in touch with what is going on while traveling between cities, and even within cities. For the apprehension of criminals, it is a most important adjunct to any police department.

\* \* \* \* \*

AT one time, it was the custom to build such car sets behind the dashboard. This was a most cumbersome arrangement, and will not prevail in the future. The new sets that are now being installed in cars work on entirely different principles. The set is installed in a metal cabinet, similar to a tool chest, which is attached right on to the running board. A flexible shaft goes to the dashboard, where the shaft connects with a single knob which is used as a tuning control. The shaft, by the way, is of the variety that dentists use to connect their motors to the dental drill.

Aside from the one tuning knob, there is also a filament switch; these constitutes all the controls for the car's radio set. The operation is simplicity itself; the switch is turned on and a station is tuned in. There is no volume control, and there is no necessity for having one; because the volume is controlled simply by detuning a trifle. This makes for great simplicity. While, in the future, some refinements may be added, yet even the present method is a good one.

During the coming year, we will witness an epidemic of radio sets for cars, which the various manufacturers will put out complete and ready to install.

\* \* \* \* \*

OF course, these sets will not install themselves; so someone will have to do the installing—and here is where the service man and radiotrician will reap a rich harvest.

It is conceivable that, by the end of the next five years, every car will come already equipped by the automobile manufacturers with a radio installed all ready to operate. But, for the next few years, there will be many cars not so equipped; and it is here that the service man and the radiotrician will be able to make a good deal of money in the installation of such sets.

RADIO-CRAFT, from time to time, will present articles on this new and fascinating subject.

### Contents of this Issue

|   | PAGE |
|---|------|
| LEAVES FROM SERVICE MEN'S NOTEBOOKS                         |      |
| By RADIO-CRAFT Readers                                      | 245  |
| LETTERS FROM SERVICE MEN.....                               | 246  |
| MEN WHO MADE RADIO—Sir Oliver Lodge.....                    | 247  |
| NATIONAL LIST OF SERVICE MEN REPLY BLANK.....               | 247  |
| SOME PRESCRIPTIONS OF A RADIO DOCTOR                        |      |
| By Paul L. Welker   | 248  |
| WHAT IS RADIO'S GREATEST NEED FOR 1930?                     |      |
| By Service Men  | 249  |
| RADIO SERVICE DATA SHEETS.....                              | 250  |
| A MULTI-METER AND TESTER—By Louis B. Sklar.....             | 252  |
| SHORT-WAVE CRAFT—The Coast Guard's Best Short Wave Receiver |      |
| By S. R. Winters  | 253  |
| R. C. A. SHORT-WAVE TELEVISION WORK.....                    | 254  |
| SHORT-WAVE STATIONS AND THEIR SCHEDULES.....                | 255  |
| VACUUM TUBES FOR RADIO RECEPTION—Part III                   |      |
| By C. W. Palmer   | 256  |
| A COMBINATION WORK-BENCH AND TEST BOARD                     |      |
| By A. Kronberg  | 258  |
| RADIO-CRAFT KINKS.....                                      | 259  |
| THE COOPERATIVE LABORATORY—By David Grimes.....             | 260  |
| THE RADIO CRAFTSMAN'S OWN PAGE—By Himself.....              | 262  |
| PRACTICAL LITERATURE FOR RADIO READERS.....                 | 263  |
| NEW RADIO DEVICES FOR SHOP AND HOME.....                    | 264  |
| SOLVING THE PROBLEM OF CITY AERIALS.....                    | 265  |
| THE DEVELOPMENT OF THE MODERN SOUND REPRODUCER              |      |
| By O. C. Roos   | 266  |
| INFORMATION BUREAU.....                                     | 270  |

### In Forthcoming Issues:

- Tri-Chromatic Television.....Herbert E. Ives
- Notes for Radio Service Men.....Bertram M. Freed
- Interference—Its Origin, Location and Elimination.....  
.....F. R. Bristow
- Experiments with 14-Centimeter Waves.....Ernst Gerhard
- Servicing the Freshman "N".....Harold Weiler
- Radio Sets and Parts Salvage.....Clyde A. Randon
- A Novel Scanning Disk.....Paul L. Clark

RADIO-CRAFT is published monthly, on the fifth of the month preceding that of date; its subscription price is \$2.50 per year. (In Canada and foreign countries, \$3.00 a year to cover additional postage.) Entered June 24, 1929 at the postoffice at New York, N. Y. as second-class matter under the act of March 3, 1879. Application pending for transfer of second-class entry to the postoffice at Mount Morris, Ill. Title registered U. S. Patent Office. Trade-marks and copyrights by permission of Gernsback Publications, Inc., 98 Park Place, New York City. Copyright 1929 by G. P., Inc. Text and illustrations of this magazine are copyright and must not be reproduced without permission of the copyright owners. We are also agents for SCIENCE WONDER STORIES, AIR WONDER STORIES and SCIENCE WONDER QUARTERLY. Subscriptions to these magazines may be taken in combination with RADIO-CRAFT at reduced Club rates. Write for information.

Published by

## TECHNI-CRAFT PUBLISHING CORPORATION

Publication Office: 404 No. Wesley Ave., Mount Morris, Illinois

Editorial and Advertising Offices  
96-98 Park Place, New York City

Western Advertising Office  
737 North Michigan Avenue, Chicago, Ill.

L. F. McCLURE, Western Advertising Representative.

# 4 of the 40 Easy Ways to Make \$3<sup>00</sup> an Hour

**T**HE four plans shown are but a sample of the many ways in which our members are making \$3.00 an hour upwards, spare time and full time, from the day they join the Association. If you want to get into Radio, have a business of your own, make \$50 to \$75 weekly in your spare time, investigate the opportunities offered the inexperienced, ambitious man by the Association.

## Our Members Earning Thousands of Dollars Every Week

The Association assists men to cash in on Radio. It makes past experience unnecessary. As a member of the Association you are trained in a quick, easy, practical way to install, service, repair, build and rebuild sets—given sure-fire money-making plans developed by us—helped to secure a position by our Employment Department. You earn while you learn, while you prepare yourself for a big-pay Radio position.

The Association will enable you to buy parts at wholesale, start in business without capital, help you get your share of the \$600,000,000 spent annually for Radio. As a result of the Association, men all over the country are opening stores, increasing their pay, passing licensed operator examinations, landing big-pay positions with Radio makers.



## Mail Coupon Today for the FREE HANDBOOK

It is not only chock-full of absorbing information about Radio, but it shows you how easily you can increase your income in your spare time. Mailing the coupon can mean \$50 to \$75 a week more for you.

**Radio Training Association of America**  
4513 Ravenswood Avenue Dept. RCA-12 Chicago, Illinois

## In Your Spare Time in RADIO

**Below** are a few of the reports from those now cashing in on the "40 Easy Ways"



**Clears \$3,000.00** Frank J. Deutch, Pa.—"Since joining the Association I have cleared nearly \$3,000.00. It is almost impossible for a young fellow to fail, no matter how little education he has, if he will follow your easy ways of making money."

**\$1,100.00 in 6 Weeks** J. R. Allen, Calif. — "Have done over \$1,100.00 worth of business in the last 6 weeks. Next month I am going to open up a store of my own. I never knew that money could come so fast and easy."

**\$25.00 a Week Spare Time** N. J. Friedrich, N. Y.—"I have averaged \$25.00 a week for the last 7 months even though I am not a graduate but just learning."

**Training Lands Him Job** R. C. Kirk, N. C.—"Your training has been very valuable to me. I landed a job with the big department store out here a few weeks ago because I had my membership card with me. There were a large bunch of applications ahead of me."

## ACT NOW If You Wish NO-COST Membership

For a limited time we will give to the ambitious man a No-Cost Membership which need not—should not—cost you a cent. For the sake of making more money now, and having a better position in the future, mail coupon below *now*. You'll always be glad you did.

Radio Training Association of America  
Dept. RCA-12 4513 Ravenswood Ave., Chicago, Ill.  
Gentlemen: Please send me by return mail full details of your Special No-Cost Membership Plan, and also a copy of your Radio Handbook.

Name \_\_\_\_\_

Address \_\_\_\_\_

City \_\_\_\_\_ State \_\_\_\_\_



# New Moisture Humidifier & Carbon Eliminator

for all Makes of Cars, Trucks, Tractors and Engines

An amazing Scientific Humidifier has been patented throughout the World that beats any ever got out. It makes engines run ALL THE TIME with the same wonderful efficiency they do on a cool moist night. It gives MORE pep and power, HIGHER top speed, eliminates hard carbon, and gives AMAZING mileage. Fords report 28 to 42 miles per gallon. Other makes (both American and Foreign) report marvelous increases of 1/4 to double mileage. Some of the best records are:

| Miles               | Miles                 | Miles                   | Miles                | Miles |
|---------------------|-----------------------|-------------------------|----------------------|-------|
| Buick.....28 1/2    | Essex.....32          | Nash.....30             | Pierce Arrow.....22  |       |
| Cadillac.....21 1/2 | Ford (Model T).....42 | Oakland.....31          | Pontiac.....31       |       |
| Chevrolet.....41    | Ford (Model A).....40 | Oldsmobile.....34 1/2   | Reo.....26 1/2       |       |
| Chrysler.....30 1/2 | Hudson.....23 1/2     | Packard.....21 1/2      | Studebaker.....29    |       |
| Dodge.....31        | Hupmobile.....24 1/2  | Plymouth.....29         | Whippet.....41       |       |
| Durant.....41 1/2   | Marmon.....21 1/2     | Graham-Paige.....23 1/2 | Willys-Knight.....29 |       |

And Hundreds of Other Wonderful Records on ALL American and Foreign Makes

## Big Profits

to Man with Car Spare or Full Time

\$350 to \$1500 a month  
 1 man \$4,939.66 in 3 1/2 months.  
 Another \$1,656.60 in 58 days.  
 \$5,150.00 in 5 months to another.  
 BIG MONEY can be—IS being made.

Fitting Motors With Vix

One man sold 8 first morning.  
 Another sells all 3 men can install.  
 Another's profits as high as \$100.00 a day.

VIX sells itself by 8 STARTLING demonstrations — BIG, STUNNING, ASTOUNDING DEMONSTRATIONS. Successful VIX men make MORE MONEY than they ever made before.

# Free Trial Try This New Principle Gas Saver AT MY RISK



Try this wonderful VIX Moisture Humidifier and Carbon Eliminator AT MY RISK on YOUR OWN CAR to prove that VAPOR MOISTURE (drawn from Radiator to Engine) gives you that wonderful night driving effect ALL THE TIME with MORE mileage from gas and oil—eliminates hard carbon accumulation — gives MORE power, a SNAPPIER, PEPPIER motor. FASTER acceleration, a SMOOTHER, QUIETER running engine and HIGHER top speed.

VIX will PROVE ITS MONEY SAVING MERIT on your own car by 8 DEMONSTRATIONS—conducted by yourself AT MY RISK—the most SENSATIONAL, most ASTOUNDING, most CONVINCING DEMONSTRATIONS you ever saw. If you don't find from your tests that it does MORE than I claim, return it and it COSTS YOU NOTHING. I want wide-awake, hustling, County, State, Province and National Agencies everywhere, part or full time, to make \$350 to \$1500 per month filling the great DEMAND for this wonderful invention wherever introduced. Write for my FREE TRIAL and MONEY MAKING OFFER. Use coupon below.

**WALTER CRITCHLOW**

Inventor and Manufacturer, 862-A Street, WHEATON, Ill., U. S. A.

## FREE VIX offer Mail Now

**WALTER CRITCHLOW**  
 INVENTOR and MANUFACTURER  
 862-A Street, Wheaton, Ill., U. S. A.

Please send me without obligation or charge your FREE TRIAL and MONEY MAKING VIX OFFER.

Name.....

Address.....

Town..... State.....

Pictures here and at top show Model "B" VIX attached to my own New Model A Ford. This car is wonderfully improved in performance with the VIX Moisture Humidifier. So is every Auto, Truck, Tractor, Taxi, Bus, Marine, Stationary and Aircraft Engine, both American and all Foreign makes.

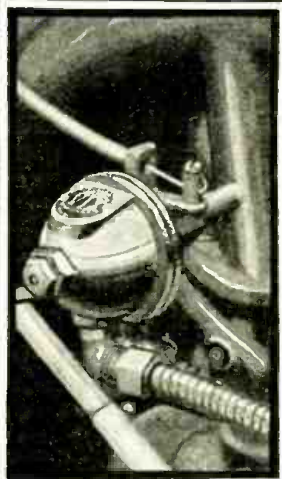

**GUARANTEED TO SAVE** { 1/4 to 1/2 Gas Carbon Cleaning Engine Repairs } **or Costs You Nothing**

# Leaves from Service Men's Note Books

*The "Meat" of What Our Professionals Have Learned by Their Own Practical Experiences of Many Years*

By RADIO-CRAFT READERS

## \$25.00 Prize Winner

### READJUSTING THE DYNAMIC-SPEAKER CONE

By Benjamin J. Spotts

THE writer has been called, on numerous occasions in the past three months, to repair dynamic reproducers in electric sets and "please take out the rattle." As I have a "Majestic 72" myself, I decided to sacrifice my own speaker to the cause of improvement, and find out what was the matter.

Here is what was found (and I am wondering yet why the radio engineers have not published it—that is, of course, if they have found it out): the cause is atmospheric conditions—the heat and moisture in the air.

The dynamic-speaker diaphragm is securely held at the periphery or rim of the cone, with a ring of *chamois skin*, or some other similar substance. Warm weather, following a period of dampness, causes this material to harden, and pull the paper of the cone slightly toward the top or sides. Sometimes the paper itself, after absorbing moisture, becomes dry and distorted. Under strong vibrations while in operation, the center of the cone, which carries the voice coil, touches the field magnet, as indicated in the illustration (Fig. A). I found out this fact by the use of ordinary automobile cylinder gauges of the feeler type.

The remedy I have found is to loosen the reproducer's clamp nuts at the outside rim, which holds the chamois skin or leather; carefully rub the skin between the fingers until it becomes again soft and pliable; and then put it back, very loosely, in the rim. In the case of the Majestic, or any other speaker having a bakelite or some such "spider" held to the field-magnet case by a small screw, I make the hole which passes this screw a little larger. The frame may then be adjusted accordingly. In only one case out of thirty-seven did I find the paper so badly distorted that I had to use a new cone. This complete job takes only

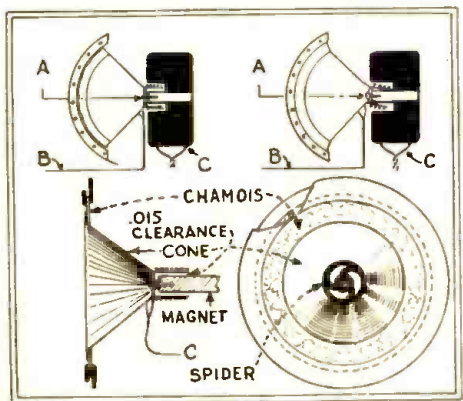

Fig. A

At upper right is shown how slight a distortion from normal adjustment (left) is needed to cause rattle. It is corrected by softening the chamois ring, as shown below.

about three-quarters of an hour to do; and it is building up quite a reputation for us. We have found on numerous visits that we had been recommended by a friend who had one of these sets serviced by us.



Assembling receiver data in loose-leaf books, classified by makes and indexed.

### CONDENSING AND FILING RADIO SERVICE DATA

By Fred McElwee

THE writer's method of compiling service data books may be of some help to the professional service man; he has acquired

#### \$25.00 EVERY MONTH

Will be paid for the most interesting story by a professional reader, containing his practical experiences and something of value to most other service men. It will appear on this page; together with other helpful contributions, which will be paid for at the regular rates. Send in your story; in any shape so long as it is both understandable and interesting. Address the Editor, RADIO-CRAFT.

a library which has been prepared from service data, received from set manufacturers and clipped from radio magazines.

A loose-leaf note book is used for each of the popular makes of receivers which we service. I use a paper punch and make holes in all the manuals, service data sheets from RADIO-CRAFT, blueprints of all the models, etc. On the first page of the book (a separate one is used for each make) I prepare an index, listing the page where each model may be found. I number each page in the book; and include also a few sheets of blank paper for notes and service data about the particular set which I have been servicing.

There is a set of these books in each service car, and one is kept in the shop. In the shop, also, we keep a data book with information on tubes, rheostats, power pack condensers, amperites, etc.

Any service manager can prepare books like these at small cost; and he or his service men will always have their service data right where they can find the information at a moment's notice.

### PROTECTING THE A.F. AMPLIFIER

By C. O. Merwin

"A.F. TRANSFORMER shot again!" "Why?" is the first question an owner of the set asks after he has had this very thing happen over and over again, and the cost of maintenance of the set mounts higher and higher.

The writer has been running a small radio laboratory in what is said by many manufacturers of audio transformers to be the worst locality in the United States (Southern Florida). Upon our returning the transformer to the factory, the same stereotyped correspondence ensues: "We are sorry that the transformer developed a defect after you had purchased it. We are replacing it free of charge." Obviously, the customer of a very fine custom-built set will start to register a heavy kick after such a thing occurs about four times a year; even though the replacement costs him nothing and the community set builder is out his time and service charges.

We have been worn dog-eared here with this trouble; so much so, that we were compelled to find some remedy. Obviously it wasn't all caused by moisture leaking in, as the manufacturers would have it. If such were the case, why then didn't the secondaries go as well as the primaries? What was the difference? Why simply this; the primary carries D.C. which the secondary did not. *Take out the D.C. in the primary* and then see what will happen. We invented an indirect method of coupling and ran test after test. We have had transformers last as long as three years with the indirect method of coupling; and then switched them around to the direct method and had them go out in two weeks. This proves conclusively that the major number of "blown" primaries are caused by D.C. surges; static encourages this sort of thing wonderfully in this part of the country.

A burst of static will cause the plate current to jump as much as 50 milliamps. when directly connected! One can visualize what is happening at the soldered connection of the

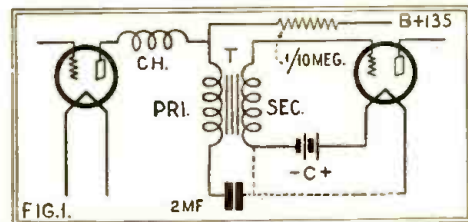

FIG. 1. A Southern custom builder finds transformers connected in the usual manner very subject to burn-out from "static." The connection above prevents this entirely.

small wire and the larger one within the transformer. This connection pulverizes in time; and the winding gradually breaks down, becomes noisy and then opens. Where two dissimilar metals, such as solder and copper, are

brought together and heated, a minute current is started; this causes a slow oxidization of the weaker metal. The whole becomes porous and the resistance rises; and this oxidization when once started keeps right on—and that is generally what happens to the audio transformer.

Fig. 1 shows the indirect method of coupling which we use; not only does it give a markedly better quality to the reproduction (the low notes come through splendidly) but it permits of a third stage of audio easily.

Fig. 2 shows a sketch of a three-stage amplifier which we have used for years with splendid success. The plate current rarely exceeds 25 milliamps, and there is all the volume one can stand in the average home. It will be noticed that the plates of the detector tube and the '01-A are returned through 1/10-meg. resistors. This system requires only one tap to be taken from the "B" battery bank. A D.P.S.T. switch should always be used; so that the "B" current is cut off when the "A" is cut. A protector tube should be used between the "A" supply and the "B"; "A+" is connected to "B—" through a 40-watt electric-light bulb. This point cannot be too highly stressed; for by-pass condensers sometimes do break down. If such trouble should occur, the protector tube lights up, saving the tubes and a lot of loss of religion.

(To prevent circuit feed-back the 40-watt lamp should be by-passed with a condenser of 1 mf. capacity.—Editor.)

### UNDESIRABLE ANTENNA EFFECTS PRODUCED BY LAMP

By W. H. Scheppele

NO doubt, every radio man is interested in the reduction of interference, man-made static, etc., encountered in the operation of receivers of the very sensitive types in use today; and has had, or will have, some unusual experiences along this line.

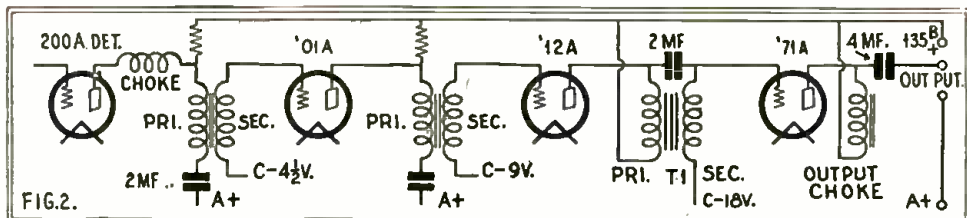

The three transformer-coupled stages above were designed to prevent transformer primary burn-outs, on the principle of Fig. 1. Keeping the plate current out of the primary also minimizes distortion.

Some time ago, the writer came up against a case of this nature in his own demonstration room. Having set up a "Silver" receiver in a particularly nice corner, I proceeded to garnish the top with a small sign easel and a medium-sized antique lamp belonging to Friend Wife, and so left it.

After using the receiver several hours I became aware of the fact that a very fine imitation of static could be produced by tapping the side of the cabinet or walking across the floor. Of course I immediately rechecked the

tubes and the receiver, and found everything O.K. It was then found that this noise could not be produced with the aerial disconnected (this receiver uses a small screen aerial fastened to the inside of cabinet top).

To make a long story short, I soon found that the antique lamp (being made of brass in two sections) had considerable *capacitive coupling with the aerial in the cabinet*; and poor connections, due to tarnish (*oxidization*) between the upper and lower sections of the lamp, had produced the "static" effects in the set.

I now use only a basket of paper flowers for decoration; and, in my journeys through my city, I wonder how many of the nicely-jointed aerials and lead-ins I see are static machines?

Moral: make it all of one wire and play safe.

To avoid "seeing stars" always discharge the condensers in the power unit with an insulated screw driver; unless the condenser is of the electrolytic type, when it is desirable to discharge it at a slower rate.

Last week, I heard a young fellow—who doesn't know a grid from a stove bolt—calmly assert that from now on he isn't going to service battery receivers any more; only All-Electrics for him, because there isn't so much danger of burning out the tubes when he works on them.



Electricity is wholesome, perhaps, but not enjoyable in this manner.

## Letters from Service Men

### Opinions and Comments on Present Trade Conditions

#### RADIO AS A SIDE-LINE

I THINK your registration idea is a good one. I have been in the radio game since about four years ago; at that time I took a course through the Radio Training Association of Chicago, and gleaned a lot of other information from magazines, etc., library books, and others I got my chance with a Philco-equipped "Radiola 28." The work was so satisfactory, in comparison with the trouble the owners experienced on other occasions, that these people told others. Result, more work; and so my business has increased. I advertised, too, in a local paper, which helped. By always giving dollar-for-dollar service, I always get the return call, at a later date.

I have meters, car, and all that is needed. I have built various sets, and in all that time, have never worked for store or radio shops; but for myself, in my spare time. Why? Because I work at the carpenter game; and, in spare time, at radio. I would accept a position where I could work at radio on part time; evenings, Saturday afternoons, etc. But the thing is that I make more in carpenter work, with radio on the side, than I could get at a full-time radio job.

JOE KOMO,  
Chicago, Illinois.

(According to a recent report of the Department of Commerce, outside of the cities of more than 10,000 population, more than 73 per cent of the radio business is transacted by dealers with whom it is a side-line. More than eight per cent of reported radio sales were made by automobile dealers, and more than four per cent by hardware dealers. What portion of the servicing of the country is done by full-time radio workers, and what portion by those skilled mechanics with whom it is a profitable side-line, is one of the questions toward the solution of which the RADIO-CRAFT NATIONAL LIST OF SERVICE MEN will be a guide. Have you filled out a copy of the questionnaire which appeared in the two previous issues of RADIO-CRAFT? If not, it is reprinted for your use, in this issue on page 247, opposite.)

#### A TIP TO THE R.M.A.

JUST what is your system of testing a radio? Until a friend of mine asked that question I don't suppose I ever gave a thought that I had a "system" of testing a radio. But, if I must explain the magic secret—

In the first place I want to emphatically

state there isn't any "secret;" knowledge, experience, and imagination are the foundation; something you have to work for to get.

Knowledge of what goes on inside the coils, condensers, and tubes, according to radio theory; the practical application as shown visually by inspection and meters; experience that teaches you just what to expect from a certain location and the complete radio installation you are working on—plus an imagination that changes you into a "bug" and you mentally crawl through the wires until you find the leak or obstacle that interferes with the normal action of a radio. Perhaps this is the "magic secret" referred to.

No two sets are alike; no two customers are the same; conditions vary in different localities; even a variation in service men due to a difference in knowledge, experience, and imagination makes it a mighty hard proposition to give any cut-and-dried system of testing and checking radios.

One store sends its service man around with a pocket full of tubes and a Beede socket meter; another service man has a Jewell, Weston, or Supreme Set Analyzer. Would you expect the same system of testing with all this varied equipment? No.

(Continued on Page 278)



# Men Who Made Radio—Sir Oliver Lodge

THE THIRD OF A SERIES

**W**HILE the inventor is nowadays the most spectacular figure in the development of a great new art, such as radio, there is always in the background, behind the inventor, the man of "pure" science. The mathematician and the researcher into the by-ways of Nature prepare the way; often many years before any practical benefit is extracted from their work by the inventor who turns it into a new, everyday necessity of life. In no branch of human endeavor has this been so apparent as in the application of electricity. The scientists made thousands, and millions, of painstaking observations; the mathematicians made millions of most complicated calculations, all in the hope that, some day, mankind could profit by their labors. "What use is electricity?" demanded a practical man of Franklin, a century and a half ago. "What use is a baby?" returned old Ben.

Among the greatest of the scientists whose life work has been to contribute to the creation of radio as a separate, and most important, branch of electricity, is the man whose thoughtful face appears upon the cover of this issue of RADIO-CRAFT. He it was who brought the prophetic calculations of Maxwell and the laboratory work of Hertz to his own generation; and he has lived to see radio, which he adopted when it was—so to speak—an orphan child, become an honored member of every home. More than that, it is the annihilator of space and the unifier of nations.

Oliver Lodge is in his seventy-ninth year; for over half a century he has been a prominent figure in the scientific world. Among the countless lines of investigation he has fol-

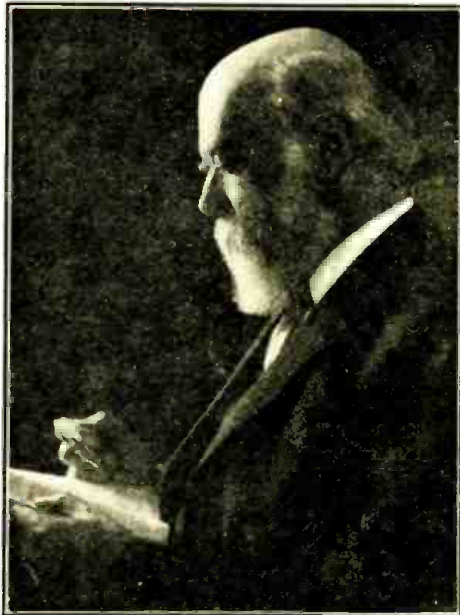

lowed in that time, that of the oscillations of electricity in a conductor is the most important with respect to our subject. While Hertz was discovering radio waves in air, Lodge was determining the laws of the cor-

responding activity which takes place in electrical conductors. It was Lodge who demonstrated the possibility of radio communication, experimentally, as Marconi did its commercial value—just as Henry created the telegraph and Morse made it of practical utility.

The discoveries of Lodge in the matter of the properties of an electric current in a liquid, and the phenomena of "ionization," have contributed in no small degree to the building up of highly-complicated modern electric theory; with its marvelous implications as to the theory of the universe. Similarly, the researches of Lodge into the actions of light—which is, after all, merely radio of invisibly-short wavelengths—are valued steps in the history of modern science. The genius of Lodge anticipated by many years the commonplaces of popular electricity today; the moving-coil or dynamic speaker, for instance, having been described by him *more than thirty years ago*.

As one of the most distinguished scientists of the present day, his fame and honors are international. A great teacher as well as a great investigator, he is a man whose wide sympathies and zeal for the spread of science have left their mark upon every field of his activity. The Grand Old Man of Radio is still vigorous; although for some years other fields of inquiry have made his name most familiar to the public at large, it is undoubtedly upon his pioneer work in the fields of electrical oscillation and radiation that his greatest permanent fame will rest.

## Attention: Radio Service Men

**R**ADIO-CRAFT is compiling an international list of names of qualified service men throughout the United States and Canada, as well as in foreign countries.

This list, which RADIO-CRAFT is trying to make the most complete one in the world, will be a connecting link between the radio manufacturer and the radio service man.

RADIO-CRAFT is continuously being solicited by radio manufacturers for the names of competent service men; and it is for this purpose only that this list is being compiled. There is no charge for this service to either radio service men or radio manufacturers.

We are hereby asking every reader of RADIO-CRAFT who is a professional service man to fill out the blank printed on this page or (if he prefers not to cut the page of this magazine) to put the same information on his letterhead or that of his firm, and send it in to RADIO-CRAFT. The data thus obtained will be arranged in systematic form and will constitute an official list of radio service men, throughout the United States and foreign countries, available to radio manufacturers. This list makes possible increased cooperation for the benefit of the industry and all concerned in the betterment of the radio trade.

National List of Service Men,

c/o RADIO-CRAFT, 98 Park Place, New York, N. Y.

Please enter the undersigned in the files of your National List of Radio Service Men. My qualifications are as set forth below:

Name (please print) .....

Address ..... (City) ..... (State) .....

Firm Name and Address .....

*(If in business for self, please so state)*

Age ..... Years' Experience in Radio Construction. .... **In**

Professional Servicing .....

Have You Agency for Commercial Sets? ..... (What Makes?) .....

What Tubes Do You Recommend? .....

Custom Builder ..... (What Specialties?) .....

Study Courses Taken in Radio Work from Following Institutions. ....

Specialized in Servicing Following Makes .....

What Testing Equipment Do You Own? .....

Other Trades or Professions .....

Educational and Other Qualifications .....

Comments .....

(Dec.) (Signed) .....

# Some Prescriptions of a Radio Doctor

*In this first article of a series by an "Old-Timer," some common ailments of Magnavox, Radiola and Stromberg-Carlson receivers are diagnosed.*

By PAUL L. WELKER

**I**N the course of diagnosing and repairing the ills of radio receivers, there are many kinks and easy remedies which cannot be learned from books; these must be obtained from personal experience. It is the purpose of this article, therefore, to hand on to the serviceman a few of the troubles encountered during a period of servicing, with an explanation of the remedies used. Many of the ills cited are common to a particular type of set and, if the serviceman knows the remedy, the trouble is easily fixed.

### 110-Volt Operation from 220

Several cases have been encountered where the customer had purchased a socket-operated 110-volt A.C. receiver while supplied with 220 volts, or had moved to a section having a 220-volt A.C. supply.

There are two possible methods whereby the set may be used on the 220-volt line. Undoubtedly the first remedy which suggests itself is the use of a resistor in series with one side of the line. This method would be wholly satisfactory were it not for the fact that the value of the resistor to be used varies

with the load and with different receivers. If there are no A.C. meters on hand, there is no simple way in which to ascertain the correct value of the resistor required to reduce the potential to 110 volts. If an A.C. meter is available, it is placed across the input terminals to the set and the variable resistor R is connected in series with one side of the line as shown in Fig. 1.

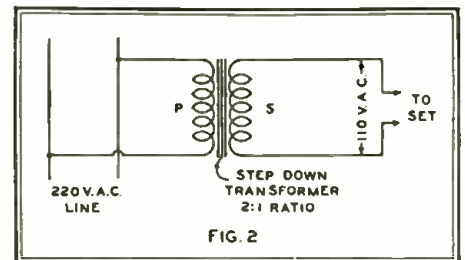

The most efficient way to obtain 110 volts from 220 is to use a step-down transformer. Note—it doesn't work on 220-volt D.C.

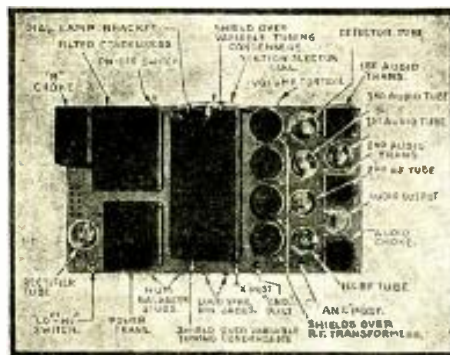

The positions of tubes, hum balancers and other parts of the Stromberg-Carlson "636" are shown above.

When all was in readiness, and the tubes inserted, the set refused to work. A careful check showed that the receiver was in perfect condition. It was noticed that the filament rheostat ("volume control") was provided with a pin which prevented it from being turned to a full "on" position. This pin was removed, as well as the fixed resistor found under the set near the front panel, protected by cardboard. Both sets functioned well after this had been done.

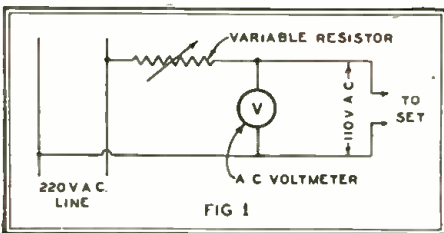

A fundamental circuit for operating 110-volt apparatus from a 220-volt line; the resistor must dissipate as much current as the set draws.

An optional method of reducing the line-voltage is illustrated in Fig. 2. Here use is made of a *step-down* transformer having a ratio of 2 to 1. The secondary is connected across the set input.

### Magnavox Receivers

In two cases the serviceman was called upon to fix old-style Magnavox receivers. Both needed new tubes besides a few minor repairs,

### Increasing Response

Certain types of receivers, such as the R.C.A. models 16, 17 and 18, Knight, Graybar (which are the same as the Radiolas) and others, use a resistor across the antenna and ground in the first stage; so that the gang control will not be affected by the size of the antenna used. These sets are all of the single-dial type and the response at the upper end of the broadcast spectrum is less than that at the lower end. A simple remedy is to take a coil (which if tuned by a variable condenser will cover the

*(Continued on Page 277)*

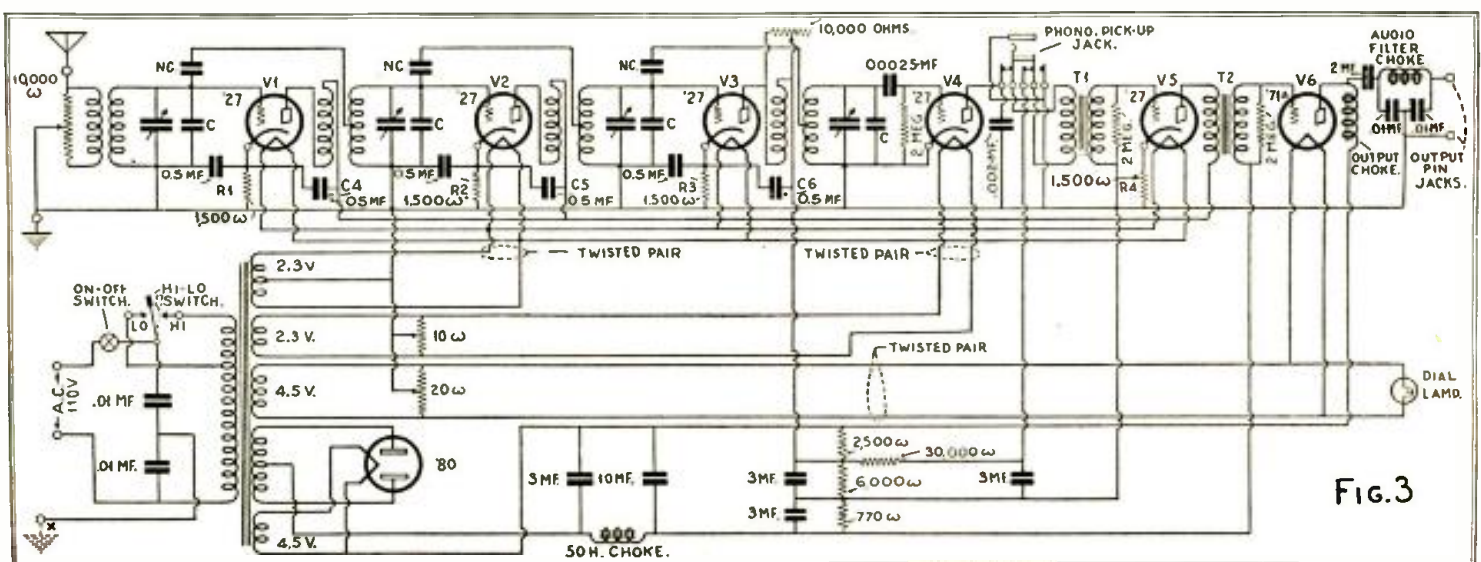

Circuit diagram of the Stromberg-Carlson "Models 635" and "636", indicating all values. The circuit is, obviously, a neutrodyne; and the service man will find little trouble in making tests and replacements, with the aid of the picture above. Manufacturer's changes in parts of the circuit, in some sets of these models, are shown in the continuation.

# What Is Radio's Greatest Need for 1930?

*The Radio Dealer and Radio Service Man Talk Back to the Manufacturer, and Tell Frankly What Should be Done to Make for Progress and Better Business.*

## CAREFUL SELECTION OF DEALERS

I AGREE heartily with the opinion advanced by Mr. J. E. Smith regarding the needs of radio for the year 1930.

If there are any manufacturers who think this not true, let them take a service kit and go out servicing sets. After a few experiences with disgruntled set owners who think they have been "gypped" because a franchised dealer failed to install the set in the proper manner, for lack of experience or knowledge of radio, or after it was installed, was unable to repair it and keep a satisfied customer, every manufacturer should know that a dissatisfied customer is a liability; but on the other hand a satisfied customer is a booster and a good sales advertisement.

So, for the future the radio manufacturer must establish a system whereby a greater cooperation can be brought about between him and his distributor, franchised dealer and customer. This can be done by having competent and qualified men install and service their receivers and also keeping in contact with the customer for a period of time after selling the set. The distributor will also have to exercise more judgment in selecting dealers, unless he can take over the responsibility in regards to servicing and proper installation. You can't expect this of grocerymen, plumbers, etc.

The manufacturer must also realize that the average service man is rendering him service he knows little about, by keeping for him a satisfied customer; and he ought to cooperate with him by keeping him informed in regards to new apparatus, etc., through magazines such as yours.

JOHN F. LYNN,  
Jermyn, Penna.

## TOO MANY PARTS DESIGNS

THE crying need for Radio in 1930 is *standardization* of those small parts that do so much of the work in a broadcast receiver and give way so often. Consider the various shapes and sizes of by-pass condensers and the divers means of mounting them. If a by-pass condenser of 0.5-mf. capacity breaks down, the (dealer's) service man usually takes the set back to the store to replace the defective part with the peculiarly-shaped one furnished by the manufacturers. He generally hasn't it in stock, and waits for the jobber who distributes that set to send one out. A standard-sized one could have been installed in the set owner's home, and everyone would be satisfied.

Compare the shapes and sizes of the "B" and "C" resistors in the Philco, Crosley and Silver receivers. They have to be that way, don't they? Oh, yes! These parts could be made with standard mounting holes and soldering lugs, just as easily as tubes with standard bases.

Yours for easier servicing,  
L. SOLOMON,  
716 Washington Ave.,  
Braddock, Pa.

## BATTERY SET STILL IMPORTANT

THERE are approximately 7,000,000 farm homes in the United States. In this vicinity, about 21% have battery-operated sets, and only about 2% A.C. sets.

This year all-electric sets have had their boom in city and small-town sales. The great majority of farm homes are not equipped with electric-light current. About 90% of the farmers who have electric-light plants have radio sets already.

Basing my assumption on the foregoing facts, there are between five and a half and six million farm homes that are in the market for battery-operated radios and, in view of this, I consider the most urgent requirement of the radio industry today the creation of a battery-operated radio working at peak efficiency with a minimum number of tubes and a minimum consumption of battery current.

The ultimate *standardization* of radio parts and circuits would also prove very beneficial to the radio retailer and serviceman. However, at present, we will just consider this a pleasant dream of what the future has in store for us.

H. H. NORDNESS,  
Whalan, Minn.

## WHAT ARE GOOD MEN WORTH?

WHAT Radio needs in 1930 is *less bumbug*. Leading chain and other radio stores in this city advertise a sale of tubes, such as RCA and Cunningham. When you ask for them, they try to sell their own pet tube. They tell you that the RCA and Cunningham tubes are inferior, so that they cannot guarantee them. The suckers, as these harpies consider the general public, fall for this hokum and pay more for an inferior article.

The cry has gone up that the run of service men is very poor. What inducements are given the trained man in the service field?

He is offered the munificent sum of as much as \$30 a week; if he can furnish a car, as high as \$42. Out of the extra \$12, he must pay for gas, oil, storage and repairs. He must furnish his own testing instruments, and work long hours for less money than a building-trades laborer.

Yours for better conditions,  
FRED ROACH,  
New York City,  
3034 Third Ave.,

IN our October issue, a formidable array of the best-known radio leaders in this country, at a request from the Editor of RADIO-CRAFT, gave their viewpoints and opinions as to what, in their minds, are the most important things that radio will need in 1930.

The Editor, in the same issue, asked the radio professionals to reply to the radio leaders, giving their viewpoint as to what the radio industry needs most for 1930. He was virtually swamped with their replies; but the best ones are printed on this page.

## EXAMINATIONS FOR SERVICE MEN

IN reading through the magazine, I read your interesting article on the demand for service men. Though I have for some time been free-lancing, the thing is of interest to me.

I began on Yaquina Bay, Oregon, in 1912, served with the army in 1916-18. The government gave me two courses, one at the College of Hawaii, and the other at Fort Kamehameha service schools. I came back to Portland, Ore., in 1920, and started my first radio building there next year. I went to work as radiotician for the Bush & Lane piano company, for whom I worked three and a half years; and again for a year as specialist on their new sets. I have worked on and successfully repaired between twenty-five and thirty different makes, and have built A.C. sets for custom trade. I have successfully combined dynamic and magnetic speakers, assembling them in a manner to prevent acoustical distortion. I have used test apparatus made by manufacturers, and now have my own, built up principally of Jewell meters.

But I have on my mind more than this: there are too many would-be radio men and junior graduates, whom the dealers out here hire because they can get their services for from \$15 to \$20 a week—anything to get by cheaply. I have listened to some of the arguments of these would-be service men to customers that would—if Marconi were dead—be enough to turn him over in his grave.

I believe that every service man should be required to pass a stiff examination as to his real ability and actual experience as a journeyman radio serviceman. I have never worked for less than \$40 a week in this line, that is why I have sought new territory and am working for myself.

If this registration is a step toward the goal of efficiency, I am forever for it.

ROLF N. JENSEN,  
Emmett, Idaho.

## GOOD MEN NEEDED

I HAVE read every issue of your magazine, and I think very much of its contents. As to what is the need of Radio in 1930, I like Mr. J. E. Smith's article, as there is a whole lot to it. What the radio trade needs is more good service men. We have firms selling radio sets here at \$5 down. You get no service, or practically none; and this turns people against a set when all it needs is a little adjusting.

One service man from a dealer told the customer that the line-voltage was only 109 and that this isn't enough to operate an 8-tube set.

That is just a sample of some of the stories I get here.

ARDEN L. CLARK,  
514 Pike Ave.,  
Massillon, Ohio.

## "BOOSTER" OR "KNOCKER," WHICH?

I NOTE that many of the leaders in the radio industry tell of radio's dire need for service men in 1930; but do these same manufacturers attempt to cooperate with the professional service man, unless he has their agency and sells their particular receivers?

Can the average music shop or service station secure from the manufacturer wiring diagrams or service sheets? Not on your life; unless, as before stated, you are selling their sets.

Illustration; a customer brings in a receiver for repair; it is of a make entirely different from the three for which the dealer has the agency. We will presume the cause of the trouble is obscure. Rapid diagnosis is necessary, and can be greatly facilitated by wiring diagrams, showing ohmic resistance values, etc.

Every service man is hampered and limited by the manufacturer's attitude. What avenues are open, to secure information? Such publications as RADIO-CRAFT and a few worth-while books (and among these the only real one, in fact, which I have been able to secure is Rider's *Trouble-Shooter's Manual*. Here is hoping that more of such high-grade, common-sense books arrive on the market).

The manufacturers who survive, and thrive to any material extent during the next five years, will be those who are open-minded enough to realize that the service man in the field can be quite a factor as a "booster" or a "knocker" in response to their attitude toward him.

Accept my thanks for the many helpful articles I have secured from your good publication.

G. M. JENKINS,  
Jenkins Music Shop,  
354 East 43rd St.,  
Chicago, Ill.

## NEWS, NOT HISTORY, WANTED

IN my opinion, one of the important needs of the radio industry for 1930 is closer cooperation between the manufacturer and the service man in the field. Radio is developing into more complicated circuits; and changing so rapidly that a service man becomes familiar with a certain model, only to find that there is a newer one with increased complications.

Just recently, I wrote to a prominent radio manufacturer, about some of his sets, only to be referred to some textbook or some radio journal. What I needed was the service sheets with the electrical values of each part, and full data on testing.

Until the manufacturers are ready to stand by the men who are in the field helping to keep their sets working 100% efficient, the radio industry will not move forward as rapidly as it should.

In 1930 we will see the radio infant, Television, growing rapidly. What radio needs in 1930 is for manufacturers and service men to work shoulder to shoulder. The manufacturer should prepare his service data and mail them in advance of putting the sets on the market. This gives the man in the field a chance to become familiar with the new circuits, and be ready to render proper service when the sets are placed on the market.

Another need is for the installation of a voltage regulator to be built into every radio set; which will save many a tube from going into the scrap pile prematurely from fluctuation in the power supply lines.

DELBERT MYERS, A. I. R. E.  
Sweetser, Indiana.

DAY-FAN FIVE "5044"

The circuit used in this receiver is reflexed. Thus, V2 functions as an amplifier of both radio- and audio-frequency currents. With SW1 in position on 1, the audio output of V2 is fed to the reproducer; in position 2, V5 is introduced as a third stage of A.F. amplification.

Units R.F. Choke 1 R.F. Choke 2 and R.F.T. 2 are iron-core instruments in radio-frequency circuits.

A Continuity Test of the receiver should check as indicated below. The reference numbers appear on the "Tube Layout."

| Terminals                | Correct     | Cause if Wrong  |
|--------------------------|-------------|---|
| Plus 90-2                | High resis. | Open or shorted R.F. Choke 1 or open lead                                 |
| Plus 90-6                | High resis. | Open or shorted R.F. Choke 2 or open lead                                 |
| Plus 22½-11              | High resis. | Open or shorted pri. of AFT1 or open lead                                 |
| Plus 90-15               | High resis. | (Sw. 1 on 2.) Open or shorted AFT2 or open lead                           |
| Plus 90-19               | High resis. | (Reproducer plugged in and SW 1 on 2.) Open or shorted reproducer or lead |
| Minus "A"-1              | Dead short  | Open RFT1 sec. or open lead   |
| Minus "A"-5              | Dead short  | Open RFAT3 or open lead   |
| Plus "A"-C3              | Dead short  | (SW2 closed.) Open lead   |
| Minus "A"-16             | High resis. | Open or shorted RFT2 sec., AFT1 sec. or open lead.                        |
| Minus "A"-20             | High resis. | Open or shorted AFT2 sec. or open lead                                    |
| Aerial-ground            | Dead short  | Open RFT1 pri. or open lead   |
| Minus "A"-2              | Open        | Shorted .001 mf. coupling cond.   |
| Minus "A"-tap 3 of RFAT3 | Dead short  | Open pri. part of RFAT3 or open lead                                      |
| Minus "A"-15             | Open        | (SW1 open) Shorted .001-mf. coupling cond.                                |
| Plus "A"-tap 3 of RFAT4  | Dead short  | Open pri. part of RFAT4 or open lead                                      |
| Plus "A"-6               | Open        | (Sw2 closed.) Shorted .001-mf. coupling cond.                             |
| Minus "A"-11             | Open        | Shorted .001-mf. by-pass cond.  |

"Off logging" may be due to the pointers having slipped, or to the rotor and stator plates of the tuning condenser not being in correct register. The former may be corrected by tuning to a particular station, loosening the pointer lock-nut, setting the

pointer to approximately the correct point for that station, and tightening the lock-nut. The condenser adjustment may require centering the rotor plates in relation to the stator plates. A lock-nut on the end of the rotor shaft is available for this purpose; it is

signed for selectivity conditions not as stringent as those of the present day, and it is not as easy now to obtain interference-free reception in congested districts as formerly.) A suggestion for obtaining additional selectivity is to connect a compact air-dielectric variable condenser from 6 to 11, adjusting it to cause regeneration. It may be mounted at a convenient point on the panel. If regeneration on the longer waves is insufficient, it may be necessary to reduce to .001-mf. the capacity of the by-pass condenser connected from the plate of V4 to "A —." Still stronger regeneration may be obtained by connecting a radio-frequency choke coil between the plate and AFT1 primary lead of V4. A safety measure recommended for these receivers when operating from "B" batteries is the insertion of a fixed condenser of .01-mf. capacity in series with the variable regeneration condenser mentioned above. A caution regarding this installation is to keep leads as short as possible, and to shield these new leads. The voltage tests of this particular model receiver were obtained with a Weston Student Galvanometer Model 375. With a 4½-volt battery supply, a 7,000-ohm series resistor is used. (An approximation of this value is secured by the use of the secondary of a "replacement" A.F. transformer.) "Sw 1" is the "Speaker Switch."

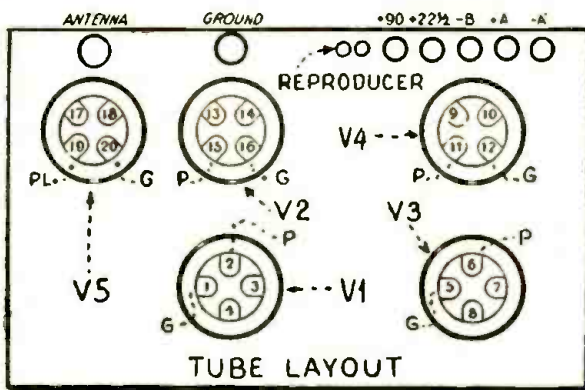

loosened, the rotor and stator plates are centered, and then tightened. If one or two of the plates remain out of alignment, they may be centered by careful bending of the plates. If difficulty is experienced in getting distant stations while locals are on, it will be well to check the length of battery leads. Those which are too long will pick up sufficient energy from the locals to cause these signals to "ride in" on top of distant station programs. The solution is to keep battery leads as short as possible.

A peculiarity of this particular receiver is that an antenna length of less than sixty feet will not (contrary to usual practice) result in greater ease of tuning through local stations; a length of more than 100 feet is also inadvisable. The explanation lies in the "selector coil" of this receiver. With an antenna shorter than sixty feet, sufficient energy is not received from the distant station to allow the selector to be turned to a point where the local station is cut out, and at the same time the distant station is brought in. In other words, a strong signal from the distant station as well as from the local allows the user to select either station by proper use of the selector. Selectivity in this receiver depends to a major extent on the setting of the RFT1 primary coil P in relation to S; reduced coupling increases the selectivity but at the same time the sensitivity, within certain limits. However, the service man may install a small variable condenser of the mica-dielectric type, inside the cabinet, and connect it in series with the antenna lead to the RFT1 primary. By adjustment of this unit and of the inductive coupling, a point of optimum selectivity and sensitivity may be obtained. (This receiver was de-

The Reflex Circuit

An explanation of the paths which the varying R.F. and A.F. currents follow may be an aid to determining the faults which may be encountered in receivers of this type.

The R.F. input is amplified by V1; R.F. Choke 1 forces the R.F. signal to pass through RFT2 to V2; here another plate-circuit impedance (AFT2 pri. or the reproducer) keeps back the R.F., which continues to V3, via RFAT3, and then to V4, being again blocked by R.F. choke 2. The A.F. output of V4 is "reflexed" through AFT1 back to V2; and the A.F. output of V2 either actuates the reproducer or is passed on through AFT to V5 (the option being determined by SW1). Consequently, V1 is the first R.F. tube; V2 is second R.F. and first A.F.; V3 is third R.F.; V4 is the detector; and V5 is the second A.F.

Other reflex receivers made by Day-Fan are the "OEM-11" 3-tube; "OEM-7" 4-tube; "OEM-7" 4-tube "Super-Selective"; and "OEM-12" 4-tube. A word picture distinguishing one from the other follows. The OEM-21 receiver has two stages of tuned R.F. and two of A.F. amplification.

The "OEM-7" receiver has one T.R.F. stage followed by another T.R.F. stage reflexed for first A.F. The second A.F. is a separate tube. The "Super-Selective" varies from this model only in the looser coupling, through the R.F. transformer; as does the "OEM-12" from the "OEM-11."

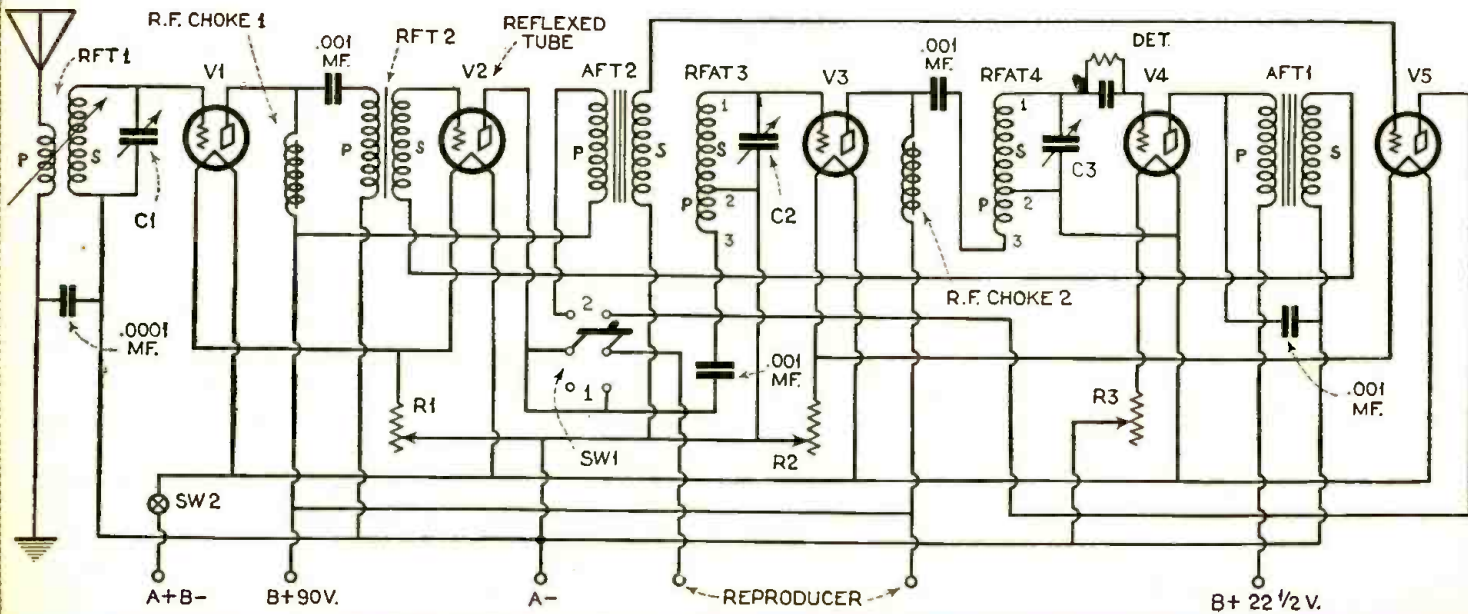

CROSLY MODEL 601

The circuit used in this receiver incorporates the Hazeltine neutralization system. Tubes V1 to V5 are '01As; V6 may be either a '12A or '71A, the latter being preferable. To take chassis from "can," remove the three knobs; remove the escutcheon by taking out the drive screws; remove two cap screws in front and two in rear, using socket wrench or pliers; raise rear of case until it clears coil shields; then slide the case forward until it clears the shafts of the tuning controls; and lift off. A total antenna-and-lead-in length of 50 to 100 feet is recommended, except where a shorter length reduces interference. For best results, ground must be connected to only one point, the ground binding post. Connection to the "A" battery may result in burning out a resistor; if set is being tested in the service shop, care must be taken that *only one ground connection is made to the set*. Study of the schematic circuit will show why this is necessary. The volume control regulates the filament current of the first three tubes; the "acuminators," or trimming condensers, resonate the secondary circuits of V2, and V3; the variable capacity in shunt with the tuning capacity in the grid circuit of V4 is an "aligning" condenser which is adjusted at the factory and has no panel control. To balance receiver, leave bottom attached, balancing with case on or off. Tune to a strong signal near 210 meters (using headphones at output) and insulate filament of V3. Insert long-shank No. 4 socket wrench (insulated handle) through balance-condenser hole in chassis (third from left, as seen from front). Tune set for loudest response and balance for minimum signal *with wrench removed*. Repeat operation with V2, using second balance condenser from left; following to V1 and balance condenser at extreme left. The "aligning" condenser is directly in front of V4. To adjust, tune to strong local with "acuminators" at about middle setting; remove V3 and tune receiver until maximum signal is heard, adjusting right acuminator as required. Insert socket wrench on aligning condenser and adjust for maximum signal, *with wrench removed*. Replace tube and adjust right acuminator for maximum signal, slightly changing setting of station selector if necessary. Acuminator should then be at or slightly above middle position. To replace R.F. transformer, remove case and bottom from receiver. With set upside down, remove the two nuts holding copper can to chassis over coil to be replaced, and lift off can. Unsolder R.F.T. leads and remove two nuts holding R.F.T. to chassis. Solder leads to lugs and replace can. If necessary to replace a tuning condenser, remove case as described, also underside chassis nuts holding condenser shield to bottom of chassis, and remove two screws on front panel holding shield in place. Press shield gently back until it clears the top edge of the front panel, raise vertically, and remove. Unsolder leads and loosen screw which controls belt tension. Remove belt from condenser pulley and remove pulley. Take out three screws attaching condenser to front panel, and remove condenser. Attach new one to front panel by three screws provided and replace pulley and belt, tightening latter. Solder leads and replace shield. Note

that it is necessary to remove indicator dial, pulley and both belts if center condenser must be replaced. To remove this indicator dial, or to replace belts, take out three screws attaching indicator dial to center pulley and remove dial. Loosen screws which

This set is not critical to antenna lengths, and will give good results with a short indoor antenna. A total length of from 50 to 100 feet for the antenna and lead-in combined is recommended for average conditions. If locals cause interference, an aerial of 25 to 50 feet, including lead-in, may give better results. The recommended lengths may be exceeded, of course, in many instances with excellent results. Local conditions must govern the choice of antenna length. A good ground should be used.

There are four binding posts on the set, two for the reproducer, one for the aerial, one for the ground. Battery connections are made to the cable attached to the set, in accordance with the color code in the preceding column.

The use of '01As throughout is recommended by the manufacturer, with a '71 power tube; though a '12 may be used to economize batteries. A separate 'C' battery is recommended for the first audio (brown lead) stage.

Lack of sensitivity, critical operation, motorboating, distorted reception, may often be checked to an open R4 leak. (Most of these effects may be experienced if the leak has too high a resistance; replace it with a leak of two to three megs. resistance.) The tube layout of this receiver is as follows: Looking at front of set, first R.F. tube socket is in left corner, front; second R.F., left, rear; third R.F. is next, followed by the detector; first A.F. socket is right rear and second A.F. or power stage is front right socket. Note that a wavelength of about 210 meters is recommended for neutralizing the receiver; but that one of about 300 meters is recommended for balancing the aligning condenser. If condensers C1, C2 and C4 should short-circuit, there is no danger of shorting "B" batteries or burning out tube filaments (as would be the case with sets using neutralizing circuits which obtain the neutralizing potential by tapping to a point on the plate-circuit coil); for the neutralizing potential in this receiver is obtained from the plate circuit inductively by means of coils L3, L6 and L9. The effect of a low-resistance short in C1, C2 or C4 will be broad tuning, circuit oscillation and weak reception. If the leads to L3, L6 or L9 are reversed, it will be impossible to neutralize the receiver; this fault will occur only if the receiver was partly re-wired during servicing, and is readily localized by following through the neutralizing process. Start from the detector tube and work toward the antenna; the stage upon which a "zero point" or silence-point cannot be obtained is the faulty one. Noisy operation during manipulation of R1 indicates poor contact. (Instead of the variation of resistance being smooth, it is being effected in relatively large jumps.) The remedy is to clean the resistor and sliding contact with sandpaper. This must be done carefully, to prevent taking out the spring tension of the slider arm, when the arm will no longer make contact with the wire. A short in condenser C6 will cause the set to "go dead," as far as broadcast reception is concerned; in this case, a test from detector plate to filament will show a lower resistance than if the resistance of the primary of T1 were effective, instead of shorted out.

control tension of belts and take off belts. Put new belts in position with drive pins on pulleys through holes in belts. Tighten tensioning screws. To replace detector by-pass condenser, or grid-leak-and-

Color Code

- Black "A-," "B-," "C+";
- Blue "B+45";
- White "B+90";
- Red "B+Power";
- Brown "C-4½";
- Green "C-Power";
- Yellow "A+."

Continuity Test

(Two test prods and a 10 w. lamp in series with the 110 v. circuit.)

| Contact  | Correct  | Otherwise            |
|----------|----------|----------------------|
| Gnd-A    | light    | Open wire or L1B     |
| Gnd-V1G  | "        | Open L1A or wiring   |
| Gnd-V2G  | "        | Open wire or L4      |
| Gnd-V3G  | "        | Open wire or L7      |
| Gnd-V4G  | no light | Shorted C5 or R4     |
| Gnd-bk.  | light    | Open wire, R1 or R2  |
| Gnd-whi. | no light | Shorted C3           |
| Whi-V1P  | light    | Open wire or L2      |
| Whi-V2P  | "        | Open wire or L5      |
| Whi-V3P  | "        | Open wire or L8      |
| Whi-V5P  | "        | Open wire or T2 pri. |
| Blue-V4P | "        | Open wire or T1 pri. |
| Blk-V4F  | "        | Open wire or R3      |

(With Headphone and Battery.)

- Connect:
- Gnd-V2G; rotate station selector; if click C7 shorted; adjust left acuminator; if click C8 shorted.
  - Gnd-V3G; duplicate above. Clicks show shorted C9 or C10.
  - Gnd-V4G; Clicks show shorted C11 or C12.
  - Green-V6G; no click shows open wire or T2 sec.
  - Brown-V5G; no click shows open wire or T1 sec.

condenser mounting, unsolder leads, remove supporting screws, place new unit in position and resolder leads. A 3-megohm grid leak is recommended.

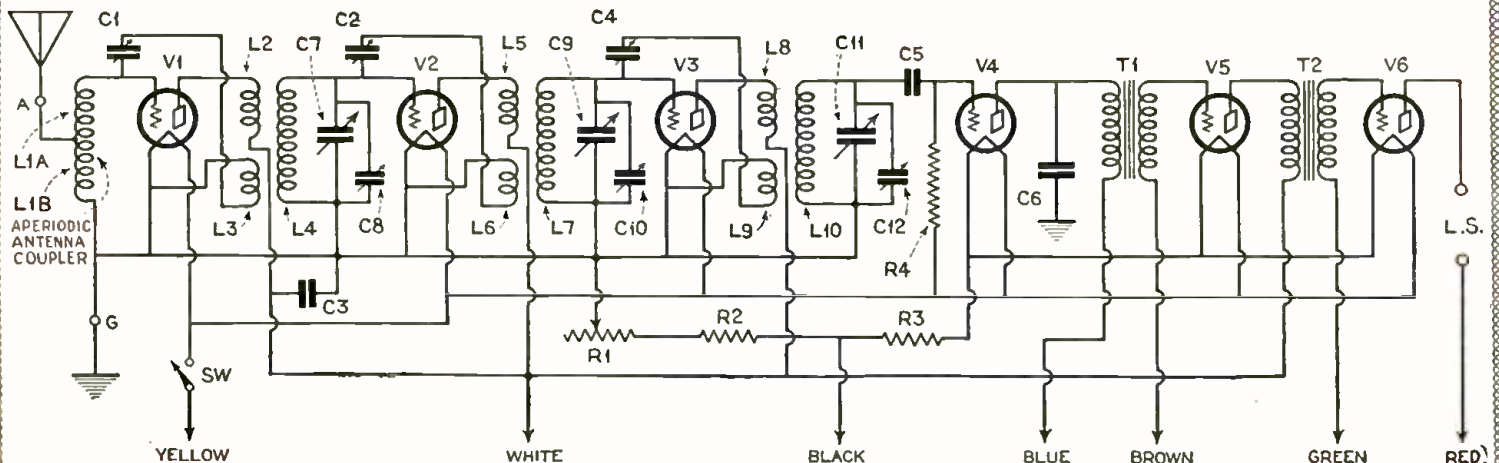

# A Multi-Meter and Tester

*An Inexpensive Arrangement Which Will Function as Continuity Tester, Ammeter, Milliammeter, D.C. or A.C. Voltmeter.*

By LOUIS B. SKLAR

**D**URING the last few months there have appeared on the market a number of radio set testers and analyzers. The writer, however, wishes to present to radio workers a radio tester of a new type, which requires only a few parts and can be built for a sum within the reach of everybody. The parts used, in most cases, can be found in the workshop.

While some of the features of this tester are not new, the writer claims, however, originality in the arrangement and design of the various electrical circuits, so that a maximum of performances can be done with a minimum number of parts. Some of the tests which can be made with this instrument cannot, as far as the writer knows, be performed with any commercial tester on the market. This set-up may be used as follows:

(1) To test the plate milliamper output of any tube, A.C. or D.C. type. By a special arrangement, described later, the tubes can be tested even when the power supply of the receiver is not functioning;

(2) As a milliammeter;

(3) As an ammeter, having one or more different ranges;

(4) As a D.C. voltmeter, of three different ranges;

(5) As an A.C. voltmeter. This feature was particularly designed so it can be used as a check for the 110-volt A.C. house current; but, by proper tapping of the resistor used for this purpose and calibration with a standard A.C. meter, it can be used as an A.C. voltmeter for other purposes.

(6) As a tube rectivator to "rejuvenate" any type of tube which is "revivable."

(7) To test for an open circuit or "ground" in the primary or secondary of an audio- or

radio-frequency transformer, or in any part of the set where a test for an open or short circuit is required.

## Parts Required

The parts required for the tester are as follows:

- 1—Readrite 0-to-25 scale D.C. milliammeter (1)
- 1—0-to-200-ohm rheostat wound with heavy wire.
- 1—Electrad 0-to-12,000-ohm wire-wound resistor (3)
- 1—Electrad 0-to-6,000-ohm wire-wound resistor (4)
- 1—Pilot UX socket, sub-panel type (5)
- 3—Pilot UY sockets, sub-panel type (6)
- 1—Sign light receptacle (7)
- 4—Small disconnecting switches (8)

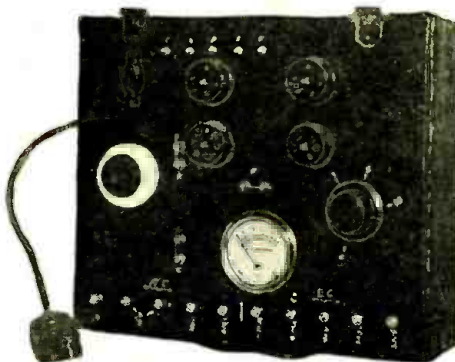

The neat panel appearance of the Multi-Meter.

- 1—Testing plug, 4-contact plug on one end and 5-contact plug on the other (9a)
- 1—Testing plug, 5-contact points at each end (9b)

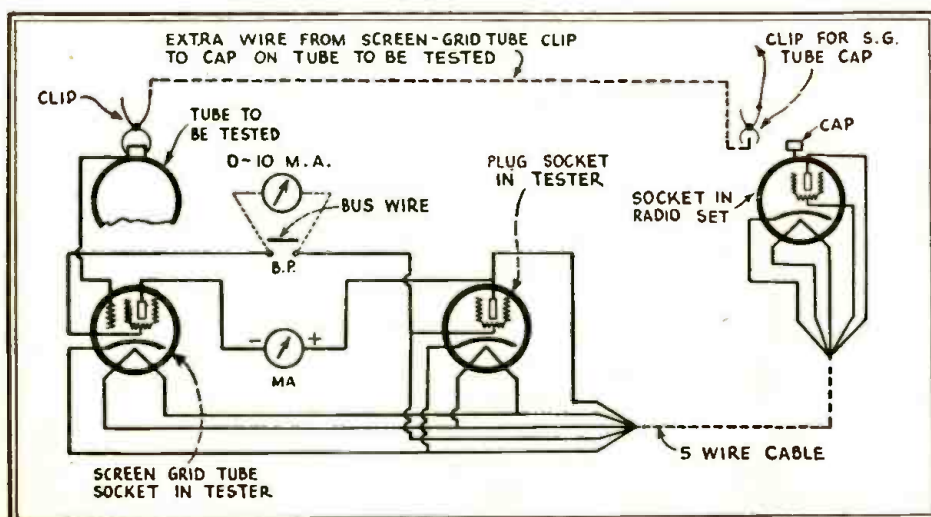

Fig. 2

Methods of testing screen-grid tubes. "Plug socket in tester" is 6B; "screen-grid tube socket in tester" is 6C



A view of the apparatus built by the writer in a convenient carrying case for use on calls, as well as in his workshop.

- 1—Electric plug for 110 volts A.C. (10)

Electric bulbs, binding posts, jumpers, etc.

Fig. 1 shows a schematic diagram of the tester; each unit is numbered according to the list above. We will go through, in detail, each test mentioned, starting with No. 1.

## Using the Tester

To get the plate-milliamper reading of any tube in the set, place one end of plug 9a or 9b (depending on the type of tube to be tested), in the socket of the radio set and the other end of the plug in socket 6b; place the tube to be tested in socket 5 for a four-prong tube or in socket 6c for a five-prong tube; the milliammeter will then give a reading for the plate current of this particular tube.

(In making this, as well as any other test, it is advisable to keep all disconnecting switches open; close them only when the test requires. Adhering to this rule will avoid burn-out tubes and injury to the meter.)

This test for plate current of a tube can be performed only if the power supply is in good condition; should there be a defect in the "A" or "B" supply, it cannot be made. Without the use of the "A" and "B" supply of the radio set, a test is made as follows:—

Put plug 10 into the house-current socket. Place an electric lamp of suitable size (the size of lamp for each tube is given in Table 1) in receptacle 7 and close switch 8b. When the electric lamp is lighted, insert the tube to be tested in socket 5 or 6c (depending on tube to be tested) open switch 8b and close switch 8c; the reading of the milliammeter will indicate the condition of the tube. (Cables 9a and 9b are not used in this test.)

(The purpose of closing 8b before inserting the tube in the tester socket is to bring the tungsten filament of the mazda lamp to its maximum temperature and maximum resistance, allowing only the proper current to flow through the radio tube; should you place the tube before the lamp has reached its high temperature, there will be a sudden rush of current with a possibility of burning out tubes.)

## Changes of Scale

Tests Nos. 2-3-4 are very simple, and there is no need for explanations. All you need for these three are two jumpers, which can be made from a piece of duplex wire and four clips. The voltmeter multipliers which are tapped from the 12,000-ohm resistance were

(Continued on Page 272)

# SHORT WAVE CRAFT

## The Coast Guard's Best Short Wave Receiver

Details of a New Four-Tube High-Frequency Set, with R.F. Screen-Grid Stage, Used by the Government Services.

By S. R. Winters

A SHORT-WAVE radio receiving set installed on the Coast Guard Cutter *Chelan* and more recently used on the U. S. S. *Utah* during a South American good-will tour demonstrated such extreme sensitivity as to equal the performance of a 6-or 7-tube outfit. Designed by the General Electric Company, this high-frequency set employs only four tubes.

able on the market, may be used in their stead.

The tuning controls are provided with a variable ratio vernier drive, and a small vernier is found on the tuning condenser of the detector compartment for fine control of the beat note. This vernier is situated between the detector-tuning and regeneration dials on the lower part of the panel.

There are three tuning controls and in

may be cut down in one of three ways—increasing regeneration beyond the critical value, reducing the input coupling, or by manipulating the plug and jack system.

### The Audio System

All of the battery leads in this receiver are provided with radio-frequency filters, and by the application of an audio filter-system to the amplifier two or more receivers may be operated from one battery supply. Without the audio-frequency filters, however, "cross talk" would develop when using more than one receiving set. The use of the output of this receiver is a variable factor—that is, it may be tapped for use in a number of ways. For instance, head telephones may be plugged into either the detector stage or the jacks of the first or second audio-frequency stages. Or, the primary winding of the output transformer (external plug and cord) may be inserted in the detector stage, first audio-frequency or second audio-frequency jacks and the head telephones plugged into either of the two upper head-telephone jacks. The output transformer supplied with this set has a 3-to-1 step-down ratio. When employing type '10 audio tubes the output transformer is intended to work into a 1,200-ohm transmission line, and when type '01A tubes are used this output transformer functions best in a 3,000-ohm transmission line. The input to this receiver may be a doublet, a transmission line, or an aerial and ground connection.

The power plant for this ultra-sensitive 4-tube receiving outfit is quite elaborate. If type '10 vacuum tubes are employed in the set, the power requirements are: Plus "A", 8-volt storage battery; minus "C", 18 volts grid biasing; detector, plus 67½ volts; four-element tube's screen-grid, plus 45 volts; radio-frequency amplification, plus 135 volts; audio-frequency amplification, plus 250 volts. If type '01A tubes are used in this receiver, the power requirements are as follows: Plus

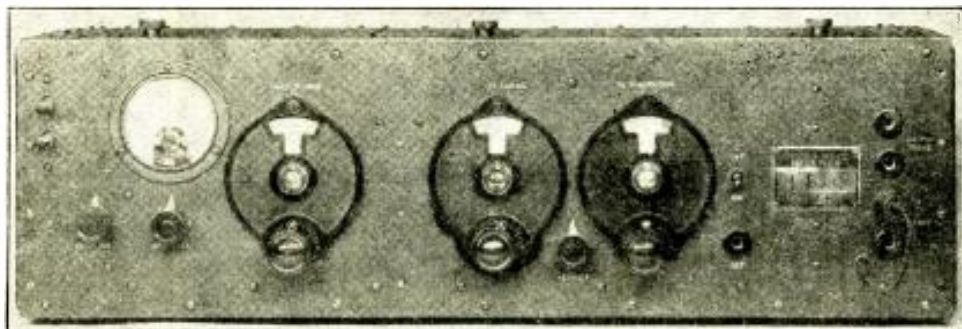

Panel appearance of the set used by the Coast Guard, with two tuning, and one regeneration, controls.

### Details of Tubes and Coils

The use of a screen-grid tube compensates for any apparent deficit in the number of tubes employed. This four-element tube is employed in the stage of tuned radio-frequency amplification and this together with a regenerative detector and two stages of transformer coupled audio-frequency amplification complete the circuit. The four-element tube is of type '22; the regenerative detector is a high-mu tube of type UX-841; and the two stages of audio-frequency amplification use type '10's. However, the type of tubes employed is a flexible factor and instead of those just outlined the high mu tube type '40 may be used in the detector stage; and a type '01A in the audio-frequency amplification stages.

This ultra-sensitive short-wave receiver is designed to cover a band of wave-lengths from 12 to 80 meters but this limit may be extended to 250 meters by the addition of tuning coils not ordinarily included in this particular design. As now constituted, there are four sets of interchangeable inductance coils—embracing, respectively, 12 to 18 meters, 17 to 28 meters, 26.5 to 45.5 meters, and 45 to 80 meters. Each set of tuning coils contains two units—one for insertion in the compartment devoted to the stage of tuned radio-frequency amplification and the other coil is plugged into the detector compartment. To facilitate the interchange of different coils, each set bears its wave-length range, engraved thereon. Any standard kit of coils of good design, obtain-

in addition to these are the following knobs which are manipulated as needs justify: Input coupling, filament voltage on the type '22 tube, the filament switch, and a stage change plug and jack system. Regeneration and wave-length increase with dial setting.

To intercept a continuous-wave signal, regeneration is maintained near but slightly above the point of oscillation as the tuning control is manipulated. *Simultaneously, the input tuning is kept in resonance by noting the increase of background noise.* The extreme sensitive setting of regeneration represents the minimum of regeneration which will permit the detector to oscillate and a beat note to be perceived. Radio telephone signals are best tuned in by keeping regeneration in close proximity to and slightly under oscillation.

The volume of the output of the receiver

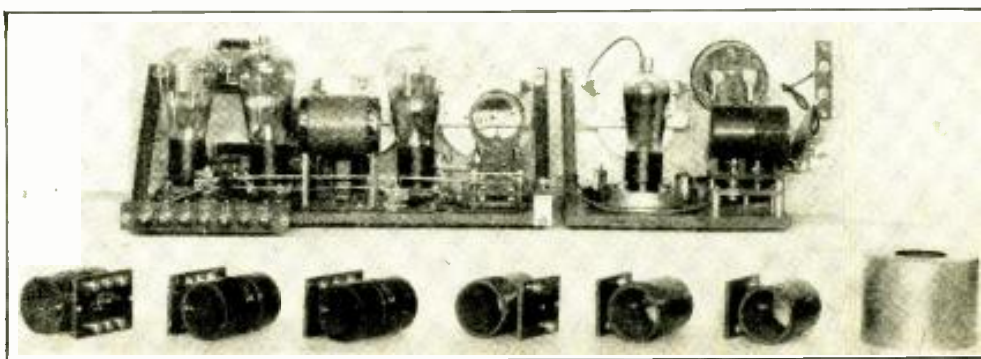

Rear view of the receiver, removed from its cabinet and shields. Two coils cover each of four bands from 12 to 80 meters; they are of the plug-in type shown in the foreground.

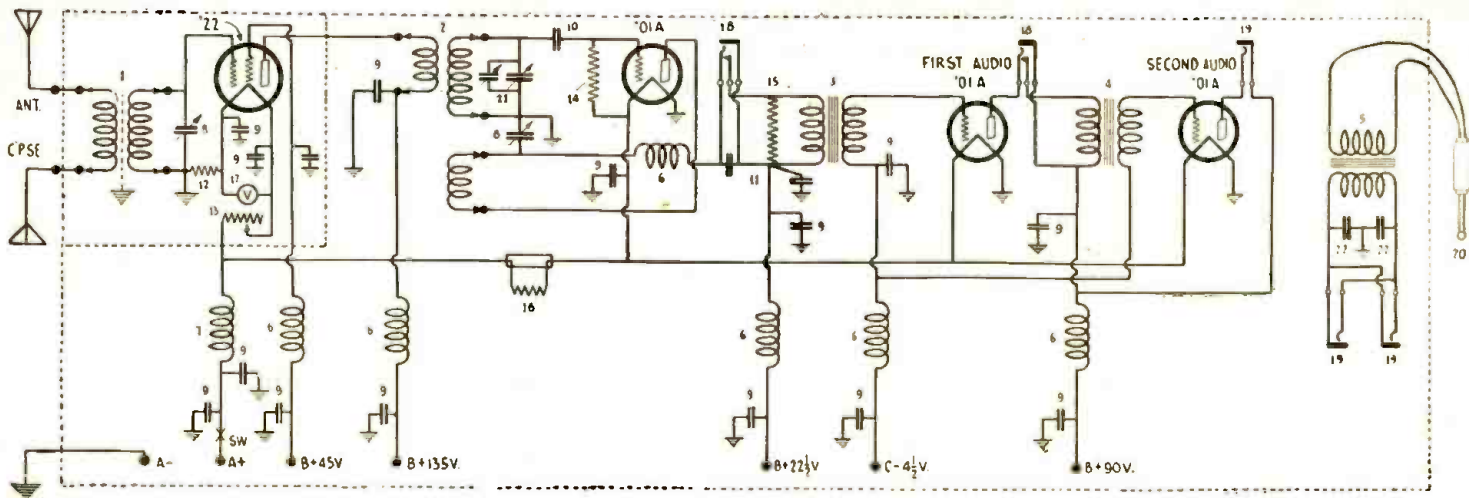

Schematic circuit of the four-tube receiver designed for the U. S. Coast Guard and the Air Service. Note the liberal use of by-pass condensers; 01-mf. capacity is used, and the filament connections are made at the tube sockets. All leads must be as short as possible; condenser ground leads less than two inches. Bias for the screen-grid tube is obtained from resistor 12; all shielding is grounded to "A-". Interesting combinations are possible with the little unit shown at the right. Units 22 are .005-mf., with center connection grounded; detector jack 18 is by-passed by .002-mf.

"A", 6-volt storage battery; minus 4½ volts grid biasing; detector, plus 67½ volts; 4-element tube screen-grid, plus 45 volts; radio-frequency amplification, plus 135 volts. In the use of either type of tubes, the minuses of the "A" and "B" batteries and the plus of the "C" battery and ground are joined together to the minus "A" binding post. The filaments of all of the tubes are connected in parallel and the failure of a tube to light is

an indication that it has burned out. If the audio amplifier oscillates, it is a sign that the "B" batteries are exhausted or their energy is running low. A one- or two-microfarad condenser across the battery will temporarily correct this condition but the "B" battery should preferably be replenished.

**Used by Air Corps**

When this high-frequency receiver was originally designed, it was subjected to preliminary trials in the flying radio laboratory of

the Air Corps, United States Army. Captain Paul S. Edwards, the radio officer, sensed the extreme sensitivity of this circuit and indicated that it would qualify as *standard equipment* for the Air Corps aircraft short-wave receiver development. Subsequently, when the new Coast Guard cutter *Chelan* went on its so-called "shake-down" cruise, it was noted that this receiver eclipsed the performance of standard Coast Guard radio outfits although the former employed fewer tubes.

# R.C.A.'s Television Work on Short Waves

*The R.C.A. Experiments at W2XBS on a 100-kc. band between 143 and 150 meters are discussed in this article.*

WE are so accustomed to thinking of the Radio Corporation of America only in connection with their commercial receiver and accessories business, that many short-wave workers fail to realize that the experimental laboratories of this organization are working practically "night and day" on the problem of successful television.

And successful television from a commercial

standpoint is quite a different thing from the laboratory or experimental product.

Recently, a demonstration of television was given to a small group and at the end of the *seance*, Dr. Goldsmith told his guests that the demonstration they had observed was, from a purely technical standpoint, of an obsolete form of television technique!

It will be of interest to learn first, about

the actual demonstration and then to compare these experiments with the later developments of the same laboratory.

**Television Demonstration**

The first consideration will be the transmitter. A line telephone connection was set up to convey verbal directions and conversa-

*(Continued on Page 274)*

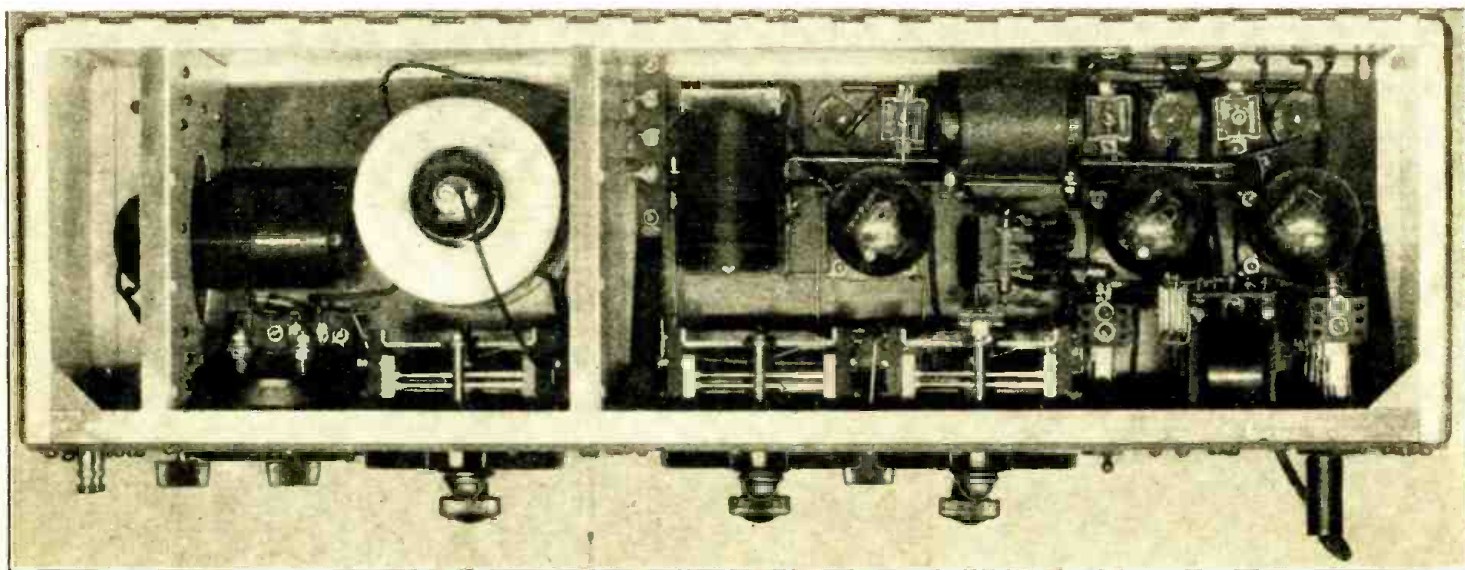

Looking into the shielded cabinet of the short-wave receiver used on the "Chelan." This receiver is a piece of standard commercial engineering; but the constructor may readily duplicate the circuit with parts available to him. While coil data are not given, any short-wave kit may be used. Note how primary of first R.F. coil (at the left) is partially shielded from the secondary. The three-connection panel strip at left of larger compartment permits leads to the screen-grid tube compartment to be rigidly shielded. R.F. chokes of the pancake variety are used.





# Vacuum Tubes for Radio Reception

*The Third of a Series, of Articles Explaining Tube Characteristics, Design, and Functions, and Methods of Manufacture and Testing; in which Power Tubes are Described.*

By C. W. PALMER

WE have considered, in previous installments, general-purpose tubes which operate on direct-current (battery) or A.C. filament supply, together with some of the special-purpose "valves," including screen-grid tubes. In this issue, we will give the characteristics of the "power" tubes, beginning with the smallest and ending with the latest.

The first tube is the '20 type; this was developed as a companion to the '99 dry-cell

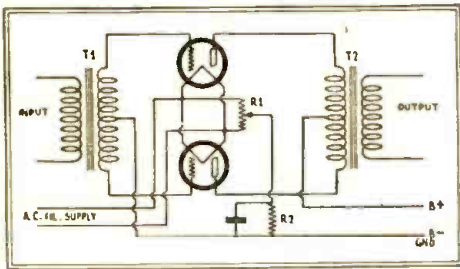

Fig. 3

Alternating current through a filament requires a center-tapped balancing resistor to take out hum, beside the grid-bias resistor.

tubes, so that better quality than was possible with the latter could be obtained. This tube has a small amplification-factor and, for this reason, is suitable for use only in the last audio stage of the set. Its filament is different from that of the '99 tube, in the amount of current required to supply the correct heat. The '99 tube requires only six one-hundredths of an ampere; the '20 tube needs thirteen (132 milliamperes). It may be operated from dry cells, if so desired; but more economical operation results from the use of a storage battery. With a 6-volt battery, a resistor of 20 ohms should be connected in the negative lead, in order to reduce the voltage across the tube to the correct value. The characteristics are:

Filament voltage, 3.3 volts; current 0.132-ampere;

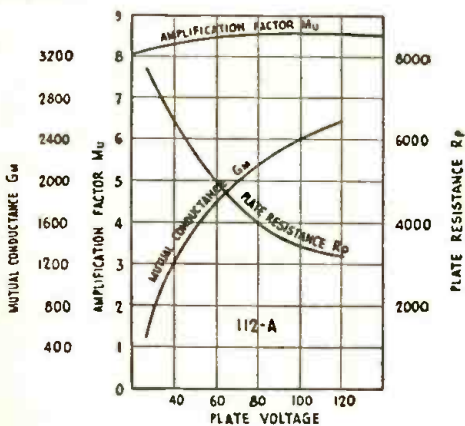

Fig. 2

The characteristics of a '12A-type tube. With the aid of graphs such as these are receivers designed.

Plate voltage, 135; current 6.5 milliamperes; Grid bias, 22½ volts; Plate resistance, 6600 ohms; Amplification-factor, 3.3; Undistorted output, 110 milliwatts.

## The '12A Tube

Next in order is the '12A type tube; the original design was known as the '12 tube, and had a filament which required half an ampere to bring it to the correct temperature. Later, the tube was changed by the substitution of a new filament, which needs only one half the current of the older type.

The '12A tube, although it was designed before the era of electric sets, is suitable for operation, not only from a storage battery, but with a step-down transformer as the filament supply. Also, because of its high amplification-factor, it is a very good general-purpose tube; even though it was not designed for this purpose. The internal capacity is comparatively small, permitting its use as a radio-frequency amplifier.

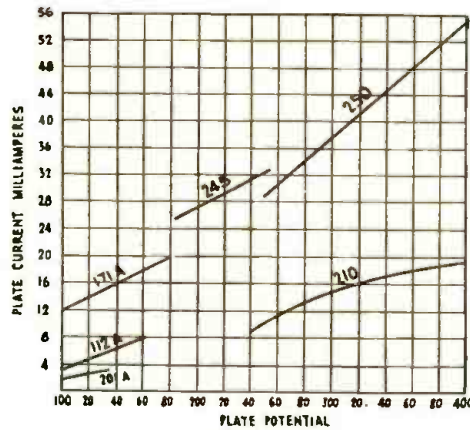

Fig. 1

A convenient chart of the comparative operating conditions of the power tubes. It does not indicate comparative outputs.

When used as a power tube, the '12A is most suitable for small sets; the undistorted output is not very great and in large sets, where the volume is high, the tube will be overloaded. Since it has a comparatively high amplification factor, (8), the volume of a small set, however, will be greater than if a tube such as the '71A were employed.

Fig. 2 shows the main characteristics of the '12A. The amplification-factor is the horizontal line at the top; it will be noticed that this is not straight, as would be the case if the "Mu" of the tube were exactly constant. It is interesting to note that the mutual conductance increases with an increase in plate voltage, while the plate resistance decreases. If a graph were made with grid voltage, instead of plate voltage, as the horizontal factor, the two volumes would also increase and decrease in the same manner.

When using the '12A tube with alternating

current, the filament circuit should be shunted by a 15-ohm resistor with an adjustable center tap. The plate and grid returns are made to this tap, which is then adjusted to the

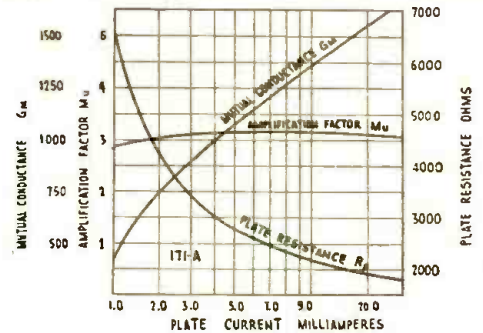

Fig. 4

The '71A gives less amplification, but more output, than the '12A. Its plate resistance is very low.

point where the least hum is heard. (If the step-down transformer has a center-tapped winding, this resistor is not necessary; for the tap on the transformer is then used for the grid and the plate returns.) This is R1, Fig. 3.

Filament voltage, 5 volts; current 0.25-ampere.

Plate voltage, 90 to 157 volts; plate current 5.5 milliamperes at 90 volts, 7 ma. at 135 volts and 9 ma. at 157 volts; Grid bias, 4½ volts at 90 plate volts, 9 volts at 135 and 11 volts at 157;

Plate resistance, 5300 ohms at 90 volts, 5000 at 135;

Amplification-factor, 8;

Undistorted output, 120 milliwatts at 135 volts, 300 at 180 volts.

## The Old Favorite

The '71A tube is the next in line; this is probably the most popular power tube ever made; it was first produced as the '71, with

(Continued on Page 279)

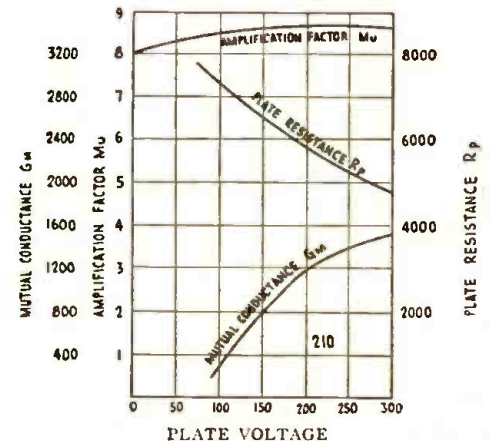

Fig. 5

The '10 tube has both high amplification and high output. Its efficiency increases rapidly as the maximum voltage is approached.

# Characteristic Data of Radio Vacuum Tubes

| MANUFACTURER   | Trade Name        | Type Number | Radio-Craft Designation | Base            | Filament Supply |       | Plate Supply  |             | Plate Resistance OHMS | Amplification Factor MU. | Mutual Conductance Micromhos | Neg. Bias VOLTS | Undistorted Max. Output Milli-watts |     |      |       |
|--|-------------------|-------------|-------------------------|-----------------|-----------------|-------|---------------|-------------|-----------------------|--------------------------|------------------------------|-----------------|-------------------------------------|-----|------|-------|
|  |                   |             |                         |                 | VOLTS           | AMPS. | VOLTS         | MILLI-AMPS. |                       |                          |                              |                 |                                     |     |      |       |
| Radio-Victor Corporation of America...   | R.C.A.            | UX120       | '20                     | Small<br>X St'd | 3.3             | .132  | 90            | 3.2         | 7700                  | 3.3                      | 428                          | 16.5            | 110                                 |     |      |       |
| E. T. Cunningham, Inc.....   | Cunningham        | CX220       | '20                     |                 |                 |       | 135           | 6.5         | 6600                  |                          |                              |                 |                                     | 3.3 | 500  | 22.5  |
| Sonatron X120; Champion UX120; Sylvania SX120; Gold Seal GSX120; Perryman PA120; Ken-Rad 120; Ce-Co E; Ray-O-Vac RX120; (same characteristics as UX120 and CX220, above)   |                   |             |                         |                 |                 |       |               |             |                       |                          |                              |                 |                                     |     |      |       |
| Radio-Victor Corporation of America...   | R.C.A.            | UX112A      | '12A                    | Large<br>X St'd | 5.0             | .25   | 90            | 5.5         | 5300                  | 8.0                      | 1500                         | 4.5             | 30                                  |     |      |       |
| E. T. Cunningham, Inc.....   | Cunningham        | CX112A      | '12A                    |                 |                 |       | 135           | 7.0         | 5000                  |                          |                              |                 |                                     | 8.0 | 1600 | 9.0   |
| Sonatron X112A; Speed 112A; Champion UX112A; Triad T112A; Sylvania SX112A; Perryman PA112A; Ken-Rad 112A; Ce-Co F112A; Eveready-Raytheon RayX112A; DeForest 412A; Ray-O-Vac RX112A; Diatron D112A; Gold Seal GSX112A; (same characteristics as UX112A and CX112A, above) |                   |             |                         |                 |                 |       |               |             |                       |                          |                              |                 |                                     |     |      |       |
| Radio-Victor Corporation of America...   | R.C.A.            | UX171A      | '71A                    | Large<br>X St'd | 5.0             | .25   | 90            | 10          | 2500                  | 3.0                      | 1200                         | 16.5            | 130                                 |     |      |       |
| E. T. Cunningham, Inc.....   | Cunningham        | CX371A      | '71A                    |                 |                 |       | 135           | 16          | 2200                  |                          |                              |                 |                                     | 3.0 | 1360 | 27    |
| Champion Radio Tube Works.....   | Champion          | UX171A      | '71A                    |                 |                 |       | 157           | 18          | 2150                  |                          |                              |                 |                                     | 3.0 | 1400 | 33    |
| Sylvania Products Co.....  | Sylvania          | SX171A      | '71A                    | "               | 5.0             | .25   | 90-180        | 10-20       | 2200                  | 3.0                      | 1400                         | 16-40           | 130                                 |     |      |       |
| Cable Radio Tube Co.....   | Speed             | 171A        | '71A                    |                 |                 |       | 135-180       | 16-20       | 2200                  |                          |                              |                 |                                     | 3.0 | 1500 | 27-40 |
| Gold Seal Electric Co., Inc.....   | Gold Seal         | GSX171A     | '71A                    |                 |                 |       | 90            | 10          | 2500                  |                          |                              |                 |                                     | 3.0 | 1200 | 16.5  |
| Ken-Rad Corporation.....   | Ken-Rad           | 171A        | '71A                    | "               | 5.0             | .25   | 180           | 20          | 2000                  | 3.0                      | 1500                         | 40.5            | 700                                 |     |      |       |
| Ce-Co Mfg. Co.....   | Ce-Co             | J71A        | '71A                    |                 |                 |       | 90-180        | 9-20        | 2500                  |                          |                              |                 |                                     | 3.0 | 1200 | 16-45 |
| Eveready Carbon Co.....  | Eveready-Raytheon | RayX-171A   | '71A                    |                 |                 |       | 90            | 10          | 2500                  |                          |                              |                 |                                     | 3.0 | 1200 | 16.5  |
| DeForest Radio Co.....   | DeForest          | 471A        | '71A                    | "               | 5.0             | .25   | 135           | 16          | 2200                  | 3.0                      | 1500                         | 40.5            | 700                                 |     |      |       |
| French Battery Co.....   | Ray-O-Vac         | RX171A      | '71A                    |                 |                 |       | 90            | 11          | 2500                  |                          |                              |                 |                                     | 3.0 | 1200 | 16.5  |
| Diamond Electric Co.....   | Diatron           | 171A        | '71                     |                 |                 |       | 135           | 16          | 2200                  |                          |                              |                 |                                     | 3.0 | 1360 | 27    |
| Triad Mfg. Co.....   | Triad             | T171A       | '71A                    | "               | 5.0             | .25   | 180           | 20          | 2000                  | 3.0                      | 1500                         | 40.5            | 700                                 |     |      |       |
| Arcturus Radio Co.....   | Arcturus          | 071         | '71A                    |                 |                 |       | 90            | 11          | 2500                  |                          |                              |                 |                                     | 3.0 | 1200 | 16.5  |
| Radio-Victor Corporation of America...   | R.C.A.            | UX210       | '10                     |                 |                 |       | "             | 7.5         | 1.25                  |                          |                              |                 |                                     | 250 | 12   | 5600  |
| E. T. Cunningham, Inc.....   | Cunningham        | CX310       | '10                     | 350             | 16              | 5150  |               |             |                       | 8.0                      | 1550                         | 27              |                                     |     |      |       |
| Sonatron X210; Champion UX210; Sylvania SX210; Speed 210A; Perryman PA210; Ken-Rad 210; Gold Seal GSX210; Ce-Co L10; Eveready-Raytheon RayX210; DeForest 410; Ray-O-Vac RX210; Diatron 210; (same as UX210 and CX310, above)   |                   |             |                         |                 |                 |       |               |             |                       |                          |                              |                 |                                     |     |      |       |
| Radio-Victor Corporation of America...   | R.C.A.            | UX250       | '50                     | "               | 7.5             | 1.25  | 250           | 28          | 2100                  | 3.8                      | 1800                         | 45              | 900                                 |     |      |       |
| E. T. Cunningham, Inc.....   | Cunningham        | CX250       | '50                     |                 |                 |       | 350           | 45          | 1900                  |                          |                              |                 |                                     | 3.8 | 2000 | 63    |
| Champion Radio Tube Works.....   | Champion          | UX250       | '50                     |                 |                 |       | 450           | 55          | 1800                  |                          |                              |                 |                                     | 3.8 | 2100 | 84    |
| Sylvania Products Co.....  | Sylvania          | SX250       | '50                     | "               | 7.5             | 1.25  | 250           | 28          | 2100                  | 3.8                      | 1800                         | 45              | 900                                 |     |      |       |
| Cable Radio Tube Co.....   | Speed             | 250         | '50                     |                 |                 |       | 350           | 45          | 1900                  |                          |                              |                 |                                     | 3.8 | 2000 | 63    |
| Perryman Electric Co., Inc.....  | Perryman          | PA250       | '50                     |                 |                 |       | 450           | 55          | 1800                  |                          |                              |                 |                                     | 3.8 | 2100 | 84    |
| Ken-Rad Corporation.....   | Ken-Rad           | 250         | '50                     | "               | 7.5             | 1.25  | 250           | 28          | 2100                  | 3.8                      | 1800                         | 45              | 900                                 |     |      |       |
| Gold Seal Electric Co., Inc.....   | Gold Seal         | GCX250      | '50                     |                 |                 |       | 350           | 45          | 1900                  |                          |                              |                 |                                     | 3.8 | 2000 | 63    |
| Ce-Co Mfg. Co.....   | Ce-Co             | 250         | '50                     |                 |                 |       | 450           | 55          | 1800                  |                          |                              |                 |                                     | 3.8 | 2100 | 84    |
| Eveready Carbon Co.....  | Eveready-Raytheon | RayX-250    | '50                     | "               | 7.5             | 1.25  | 250           | 28          | 2100                  | 3.8                      | 1800                         | 45              | 900                                 |     |      |       |
| DeForest Radio Co.....   | DeForest          | 450         | '50                     |                 |                 |       | 350           | 45          | 1900                  |                          |                              |                 |                                     | 3.8 | 2000 | 63    |
| French Battery Co.....   | Ray-O-Vac         | RX250       | '50                     |                 |                 |       | 450           | 55          | 1800                  |                          |                              |                 |                                     | 3.8 | 2100 | 84    |
| Diamond Electric Corp.....   | Diatron           | 250         | '50                     | "               | 7.5             | 1.25  | 250-450       | 28          | 2100                  | 3.8                      | 1800                         | 45-84           | 900                                 |     |      |       |
| Triad Mfg. Co.....   | Triad             | T250        | '50                     |                 |                 |       | 350           | 45          | 1900                  |                          |                              |                 |                                     | 3.8 | 2000 | 63    |
| Radio-Victor Corporation of America...   | R.C.A.            | UX245       | '45                     |                 |                 |       | Large<br>St'd | 2.5         | 1.50                  |                          |                              |                 |                                     | 180 | 26   | 1950  |
| E. T. Cunningham, Inc.....   | Cunningham        | CX345       | '45                     | 250             | 32              | 1900  |               |             |                       | 3.5                      | 1850                         | 50              |                                     |     |      |       |
| Champion Radio Tube Works.....   | Champion          | UX245       | '45                     | 180             | 26              | 1950  |               |             |                       | 3.5                      | 1800                         | 34.5            |                                     |     |      |       |
| Cable Radio Tube Co.....   | Speed             | 245         | '45                     | "               | 2.5             | 1.50  | 180           | 26          | 1950                  | 3.5                      | 1850                         | 51.5            | 1600                                |     |      |       |
| Perryman Electric Co., Inc.....  | Perryman          | PA245       | '45                     |                 |                 |       | 250           | 32          | 1900                  |                          |                              |                 |                                     | 3.5 | 1850 | 51.5  |
| Gold Seal Electric Co., Inc.....   | Gold Seal         | GSX245      | '45                     |                 |                 |       | 180           | 26          | 1950                  |                          |                              |                 |                                     | 3.5 | 1800 | 33    |
| DeForest Radio Co.....   | DeForest          | 445         | '45                     | "               | 2.5             | 1.50  | 250           | 32          | 1900                  | 3.5                      | 1850                         | 50              | 1600                                |     |      |       |
| Arcturus Radio Tube Co.....  | Arcturus          | 145         | '45                     |                 |                 |       | 180           | 26          | 2150                  |                          |                              |                 |                                     | 3.5 | 1350 | 33    |
| Ken-Rad 245, same characteristics as UX245; Ray-O-Vac RX245; Diatron 245, same characteristics as GSX245.  | Ken-Rad           | 245         | '45                     |                 |                 |       | 250           | 32          | 2000                  |                          |                              |                 |                                     | 3.5 | 1750 | 50    |
| Ken-Rad 245, same characteristics as UX245; Ray-O-Vac RX245; Diatron 245, same characteristics as GSX245.  |                   |             |                         |                 |                 |       |               |             |                       |                          |                              |                 |                                     |     |      |       |

# A Combination Work Bench and Test Board

*A Workshop Necessity which is Easy and Cheap to Build, with Suggested Instrumental Layout for General Use.*

By A. KRONBERG

**F**OR the workshop of the experimenter, as well as that of the service man, a good work bench, a test board and a toolrack are real necessities. These may be combined into one unit which places all tools, testing apparatus, etc., within easy reach and thus saves both time and labor. As, in the near future, a great many A.C.-operated sets will have to be taken into the shop for replacements, this combination should appeal to the service man who wants what he wants *when* he wants it.

The test-board should be equipped with accurate meters; as those of the cheap kind do not give accurate readings, because of the excessive current drawn. The workbench should be equipped with aerial and ground connections, an A.C. duplex outlet, and a vise; as shown in Fig. 3.

### Material Needed

The parts and lumber required for the construction of the combination here described and illustrated are as follows:

#### WORK BENCH

Lumber: 2 boards 44"x10"x1"; 4 boards 6"x3/4", two 44" long, two 18 1/2"; 10 pieces

2x4—four 30" lengths, two 38 1/2", two 14 1/2", two 10 1/2". (One more 38 1/2" and two 10 1/2" lengths of 2x4, indicated in Fig. 3, are optional);

1 small vise;

1 "Ant" and 1 "Gnd" binding posts; and 2 bakelite strips, 1 1/2"x3/4", for mounting them;

1 duplex flush receptacle and plate for A.C. outlet;

15 feet duplex lamp cord;

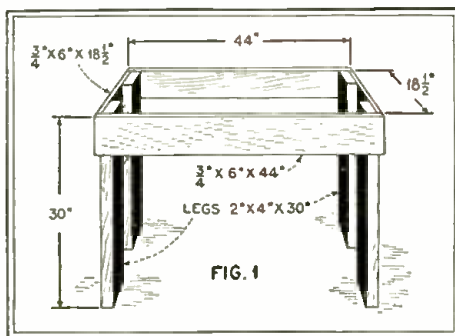

The first step—the foundation unit on which the workbench is built. The bracing frame of Fig. 2 fits snugly inside.

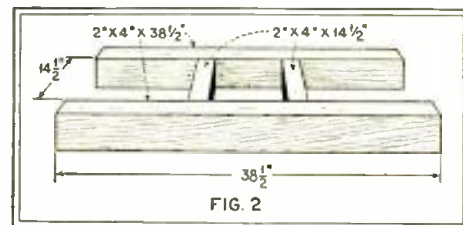

The frame supporting the table-top.

10 carriage bolts and nuts, 3" long;  
16 flat- or round-head screws, 2";  
16 flat-head screws, 2 1/2";

#### TEST BOARD

10 pieces ceiling lumber, 2" wide, 44" long; and 4 cleats, 2"x2"x26";  
1 bracket lamp and pull-chain socket;  
1 Hoyt voltmeter, 0-100-500 scale (resistance, 1000 ohms to 1 volt);  
1 Hoyt rotary volt-ammeter, 0-10-100 ma., 0-10-amp., 0-10-200-volt, D.C.;  
1 Hoyt A.C. voltmeter, 0-3-9-150 scale;  
1 Jewell capacity meter, 1 1/2-15-mf.;  
3 bakelite panels, one 6"x12", two 6"x6";  
8 carriage bolts and nuts, four 3", four 2";  
12 phone-tip jacks;  
12 round-head screws, 1 3/4"; and  
A sufficient number of galvanized cleats, shaped to hold tools (as in Fig. 3) with screws to fasten them to test-board.

#### Construction of Table

The two longest thin boards (44x6x3/4") are fastened to one end of each of the 30-inch legs (2x4) on the 2-inch sides; leaving a space of 3/4-inch outside each leg, to overlap the end boards. The latter (18 1/2x6x3/4") are now fastened, as shown in Fig. 1, to the ends of the sections just completed. Keep their ends tight against the lips of the front and back strips, which extend just far enough beyond each leg to overlap the end boards. Use two 2-inch screws, on front, back and end boards, for fastening to each leg.

Then fasten the two 10 1/2-inch lengths of 2x4 to the end boards, between the legs; keeping their top sides flush with the tops of the end boards, and using two 3-inch carriage bolts to each piece. They may also be tacked to the legs, by driving nails in slantingly from the top and bottom of the ends.

Lay out the two longest 2x4 pieces (38 1/2" lengths) with their two-inch sides up; nail the 14 1/2" lengths across and inside them, as shown in Fig. 2; and bolt this frame inside the top of the foundation. The top of this frame should be flush with the top edge of the boards, and it should fit very snug. A little of the front 2x4 should be cut away at the bottom, left, to give a place for the A.C. receptacle.

(Continued on Page 281)

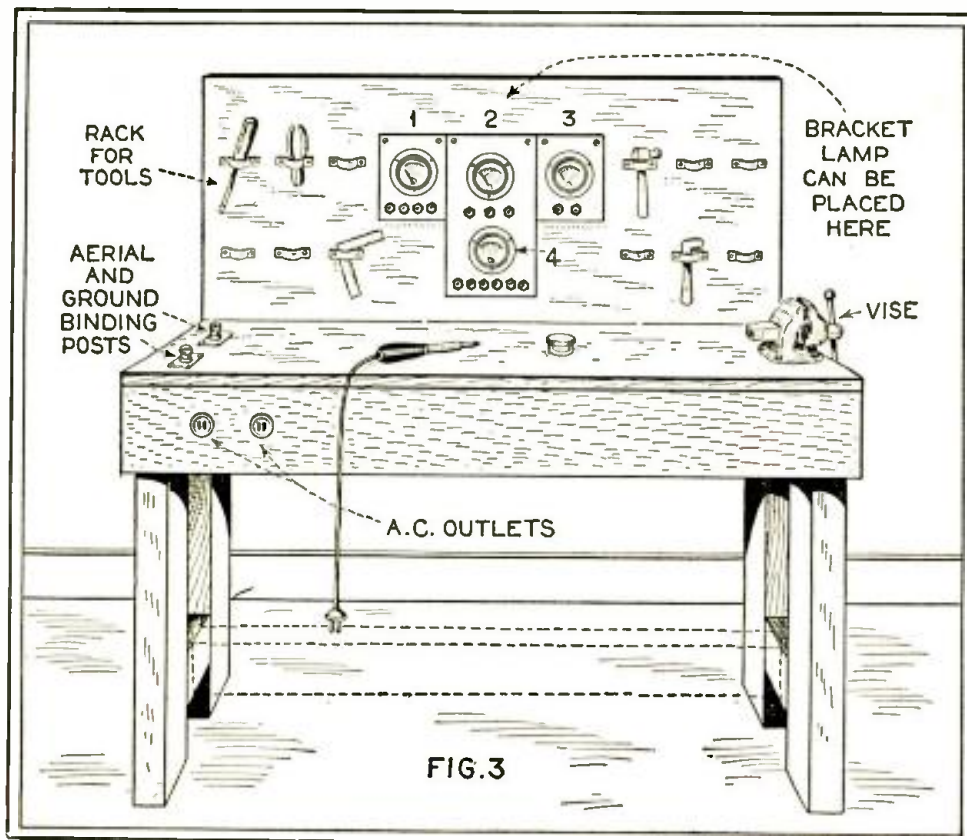

The completed workbench with its backboard for tools and instruments. Those listed in the article were used by the writer; but the builder will, of course, select his own to suit his purposes and pocketbook. The dotted cross-brace is not essential, but strengthens the table.

# RADIO CRAFT KINKS

*The two readers of RADIO-CRAFT who send in the greatest number of ingenious Kinks each month will be awarded, each, a copy of "The Radio Amateur's Handbook," a work well known for its value; in addition to the space rates paid for all articles printed.*

## A USEFUL SERVICE LAMP

By Victor A. Ulrich

A VERY handy device for looking around corners and in crannies of deep consoles is illustrated. It is an inexpensive arrangement.



The lamp thus connected may easily be carried in a servicer's kit; and guarantees him good light to examine connections.

The parts required are an automobile dashboard socket, a six-volt lamp for same, a couple of connection clips, some wire, and a block of wood.

If a particularly bright light is desired, with a slightly increased current drain, gas-filled, high candle-power headlight bulbs of the same voltage may be used.

By following the design shown there will be no danger of short-circuiting the connections of the lamp or those in the set.

As most experimenters know, lamps may be operated from either an A. C. or a D. C. source of the correct voltage.

## UTILIZING A GALVANOMETER IN TESTING WORK

By J. M. Conesa

ELECTRICAL meters are the eyes of the radio experimenter and service man, for spotting trouble, and I am a close adherent and zealous user of these valuable electrical devices. I know of many a service man who still depends upon guesswork, a pair of phones with a battery, or 110-volt line with a lamp in series, as the only means of locating faults, disregarding other factors and ignoring the actual cause of the trouble. For most service men are interested only in shorts and breaks in the wiring; and anything else is immaterial to them.

A continuity test is all that is required in most cases, but there are instances where partial breaks or shorts occur and a phone or lamp test yields very little information, if any.

In radio circuits we are dealing with unseen conditions and we must depend on some instrument by which we may visualize faulty conditions.

A galvanometer (or a low-reading milliammeter—which is practically the same instrument, in principle) is the ideal device for testing; and very valuable information may be gained through its use.

With a small "C" battery and a variable high resistor in series with the instrument a number of different tests may be performed.

### Be Careful with Instruments

This combination is exceedingly helpful for testing windings in audio-frequency transformers and, by taking readings, we may determine the approximate transformation-ratio of the windings and establish the identity of the primary and secondary when these are not marked. Other comparative tests of resistance may be performed, as one becomes

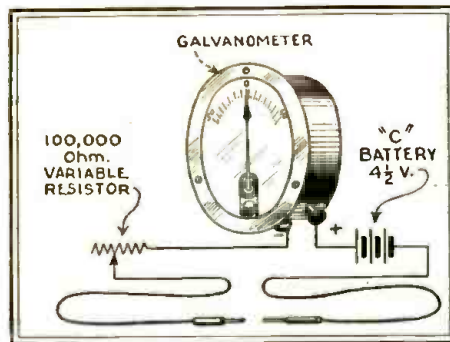

A galvanometer (or milliammeter) takes the guesswork out of servicing. All data sheets are based on the assumption that the service man has means of measurement.

more familiar with the possibilities of this valuable instrument for radio testing.

Care should be taken, when making the necessary connections to the instrument, that the resistance is at a maximum and of a value of at least 100,000 ohms, when first

closing the circuit with the battery in series. These instruments are very sensitive and delicate, and may be damaged even with a small run down battery.

By varying the resistor, we may readily adjust the pointer to any desirable place on the scale, and the instrument is then ready for use. The same procedure as in the case of phone testing is followed; but instead of hearing clicks we watch the deflection of the pointer.

## AN INEXPENSIVE ELECTRIC SOLDERING IRON

By Bernard T. Ring

A N inexpensive, low voltage electric soldering "iron" that will work on a 4, 6, or 12-volt storage battery, or on a toy transformer up to 25 volts can be made by following these constructional details.

The parts required are one screw-driver handle; one piece of brass or copper tubing, 3/8-in. dia., by 6 in. long; three clips; two gas tips; some flashlight battery carbons and a single strand of lamp cord about five feet long.

We may segregate the construction into seven operations, as follows:

(1) Enlarge the hole in the handle of the screwdriver until it is about 3/8-in. dia. and 2 in. deep; then, bore a hole all the way through, 3/16-in. dia.

(2) Thread the brass tube at one end so the gas tip can be screwed on. (Fig. 1A).

(3) Solder one end of the single-conductor lamp cord into the end of the brass tube which is not threaded. If a soldering iron or a torch is not available, a few short pieces of bus bar made into a "V" shape and twisted around the point with the end of the lamp

(Continued on Page 281)

The electric soldering iron shown will work from either direct or alternating current, up to 25 volts; its construction is simplicity itself. An insulating handle, shown at B, a brass tube A, and a gas tip C are the essentials. It is well to paint the brass tube with insulating compound, or tape it; so it cannot be shorted by other things during the soldering process. Changing tips is done by unscrewing the gas tip, taking out the carbon tip and inserting another.

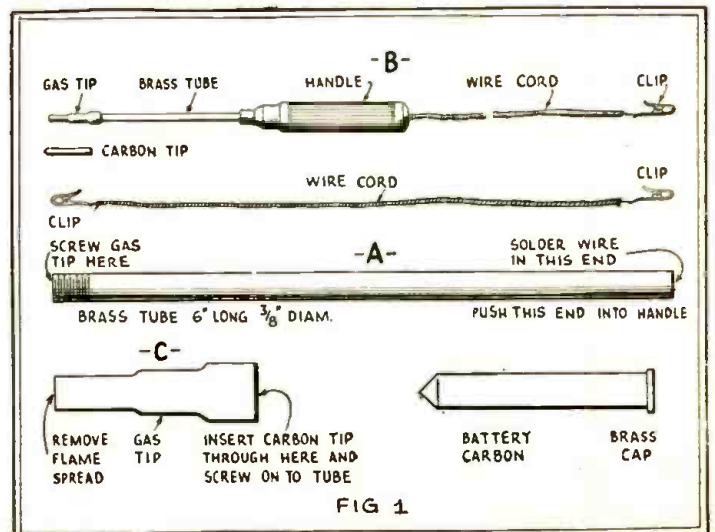

FIG 1

# The Cooperative Radio Laboratory

This Month the "Lab." Delves into the Intricacies of the Design of an A.C. Electric Receiver Employing the "Hybrid-Tube" Circuit Previously Described, with Band-Pass "Tandem Tuner" and '45 Power Stage.

DAVID GRIMES

Director

IT is but natural that we should adapt our hybrid-tube circuit to alternating current operation. During preliminary experimental stages, it is well that as many difficulties be dispensed with as possible; so straight battery circuits were first employed. But, now that most of the wrinkles have been ironed out, we can proceed with some degree of assurance to electrify the receiver. It will be of interest to you to know that this is the procedure followed in many large research laboratories. Furthermore, there are still many experimenters throughout the country who would rather operate on the steady voltages obtainable from batteries, and who do not object to the extra care they demand.

Fig. 1 is given as a starter; this covers the entire over-all circuit with details. This method of introducing a subject is rather a departure; it is customary to work up to the whole with fear and trembling; but there are many of you who are sufficiently well versed in the art to proceed with better facility if all cards are placed on the table. Hence Fig. 1. We will develop the various ideas by describing the operation of the circuit, starting with the antenna. In this way, you will be able to recognize the functions that have already been explained in previous issues in connection with battery operation.

The signals are picked up in the antenna and are brought down to the earth through the specially-tapped antenna primary winding, L1. The coil has five taps on it, arranged "geometrically," at the second, fourth, eighth, sixteenth, and thirty-second turns; the full constructional details of this coil have been covered in past numbers of the "Cooperative Laboratory." Then the signal is resonated in the first winding L2 of the tandem-filter circuit; this is the usual secondary of 100 turns,

tuned by a variable condenser in the well-known manner. But, in series with this coil, is the tapped primary L3 of the succeeding tuned transformer; this primary of six turns is tapped at the center. From the tuned secondary L4 of this second coil onwards, the operation is similar to that experienced in standard tuned-radio-frequency circuits.

### Controlled Selectivity

The operation of the tandem tuner is rather unique; it is a rather new commercial application of an old technical idea. It is a system for increasing the selectivity without cutting off the side-bands, or otherwise affecting the quality adversely. Such devices are sometimes called "band-pass" filters; an idea of their action may be obtained from a study of Fig. 2. A little explanation is in order on this, even though some information has been given

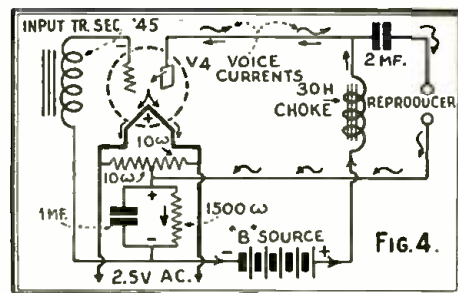

The alternating "signal" currents in a power-tube circuit are shown by wavy arrows; the direct plate current by straight arrows.

Fig. 2 is obtained. The strength of the elusive station is increased, and the increased selectivity permits the suppression of the interfering local. The answer is satisfaction.

By the way, it must be obvious to some of you that this coupling will vary over the wavelength band according to frequency, even though the number of taps is left fixed. In other words, the degree of coupling on the three-turn primary is greater on the short broadcast waves than at the 500-meter setting. This means that the band-pass will perform somewhat irregularly throughout the tuning range, but this is true of all present band-pass filters. There is a very fertile field for the experimenter in making such a device fairly uniform at the various frequencies encountered in broadcasting. It should be as important as the uniform-amplification R.F. circuits which have been so valuable. Perhaps a rotating primary in place of the taps will do the trick; this has been suggested by David Moscowitz of Newark, N. J.

### Use of A.C. Tubes

There really isn't as much to this A.C. electrification as appears on the surface. The unusual features that arise from the use of a separate heater and the cathode are about the only departures from standard practice. Certainly, the "B" eliminator end of the A.C. circuit is old; there is no difference here in any respect. We will therefore devote our time to a description of the filament and "C" bias circuits.

Heater-type tubes are used throughout the entire circuit, with the exception of the last power tube; experience has taught the engineering profession that this is the only real way to eliminate the hum. The fact that the cathode requires several seconds to heat up to the proper operating temperature, and as many more to cool off again, makes it free from any rapid variations in filament or heater currents such as are encountered in 60-cycle

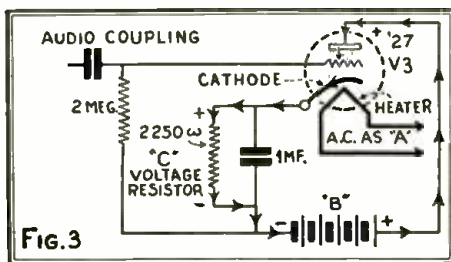
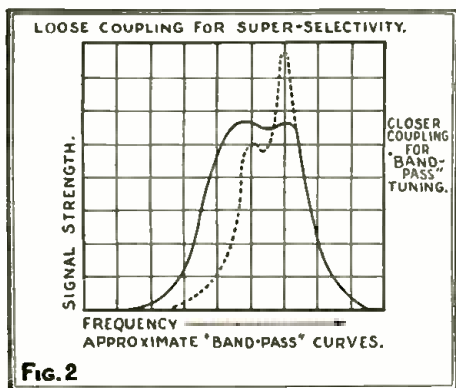

Plate current in a heater-cathode tube follows the path above (conventional direction indicated); "C" bias equals the voltage drop in the resistor.

before. You see, we have added to the tandem-tuner primary the tapped feature which was not shown before. It is quite important; for it permits increased selectivity under certain extreme conditions where a sacrifice in tone quality may be tolerated.

For all ordinary operation the filter is set with the maximum primary of six turns. This gives a performance indicated by the flat-top curve shown in the heavy line of Fig. 2. The width of the curve at the top is about 5,000 cycles—just sufficient to pass the program without discrimination. Now, there are locations and times when greater selectivity than this must be had, if that desired station is to be brought in through the maze of locals. Such a condition exists, in many places in New York City, in connection with WLW, the Crosley station in Cincinnati, and WOR, the Bamberger Station in Newark, N. J. With the selectivity shown in the flat-top curve, it would be impossible to work through WOR to bring in WLW. Here is where the tapped feature comes into play; by reducing the primary to half its normal turns, the peaked selectivity curve shown in the dotted lines in



The characteristics of the band-pass "Tandem Tuner" whose construction is described. The heavy line shows the tuning effects with close coupling; and the dotted, the sharpest cut-off.

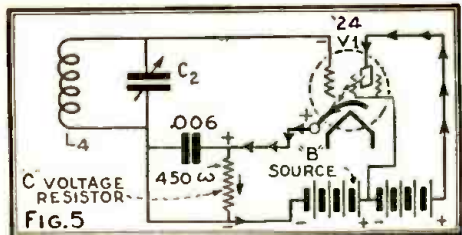

The A.C. screen-grid tube requires a lower value of resistor, to give its lower grid bias.

alternating circuits. The necessity for such a precaution in the last audio stage is not paramount; for the amplification here is not great enough to cause any trouble.

All of the heaters are connected to one 2½-volt winding of the power transformer, while the filament of the last power tube is run on raw A.C. from a separate 2½-volt winding of the power unit. It might appear that all of the tubes could be connected to the same filament winding, because the same voltage is used throughout. Some success has been obtained along these lines; but it is much better to keep the power amplifier on a separate winding. If this precaution does nothing else, it enables us to place the proper "C" bias on the last tube and, at the same time, keep the other heaters at ground potential. This statement may not be exactly clear at the moment; but wait until we have covered the "C" bias circuits.

"C" Bias Resistors

Fig. 5 should next be studied; this shows a section of the first R.F. amplifying tube circuit. It is necessary to understand this action quite thoroughly in order to make the proper circuit connections for the "C" bias. A superficial inspection of the drawing will disclose the fact that "plate" currents flow in both the regular plate circuit and, also, the screen-grid circuit; because the latter operates as a regular plate. These two currents combine in the electron stream in the tube and flow together through the hot cathode back to the negative end of the "B" supply. Now, if we place a resistance in series with this return path between the cathode and the "B—," the total electron current must pass through it. This current will create a voltage drop across the resistance and, since the current is flowing from the cathode down through the resistance, the voltage drop will make the cathode positive compared with the "B—" end of the resistance. All we have to do

then to make the grid negative with respect to the cathode is to connect the grid return directly back to "B—." If this is difficult to see, just figure that we are making the cathode positive with respect to the grid; which is equivalent to making the grid minus with respect to the cathode.

It is essential to calculate the amount of both the "plate" currents in order to determine the value of the biasing resistor. With 180 volts on the plate and 70 volts on the screen-grid (the values recommended for best operation) the resistance works out at about 450 ohms, which gives a little more than 1½ volts, negative bias on the grid. The resistor is by-passed by means of a good husky R.F. condenser; so that R.F. currents flowing in the plate circuit will not impress R.F. voltages back on the grid. This would constitute a feed-back circuit; and, unfortunately, it gives a bucking action and the amplification is greatly diminished. Ample by-passing is necessary.

Audio Amplification

Fig. 3 should be fairly clear in view of the above explanation. The difference between the R.F. tube and the audio grid-biasing system is entirely one of design and not theory. The plate current is passed through a biasing resistor on the way from the cathode to the "B—" return. In this case, we have somewhat less current to contend with, because we do not have the extra flow of the screen-grid; and the plate voltage is less on the

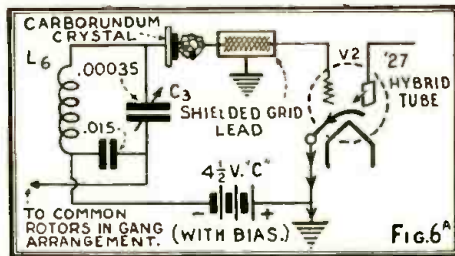

In the circuit of a '27 tube in the "hybrid-tube" hook-up, there is a 4½-volt bias on the grid through the crystal. It is best applied by a battery, to insure against hum.

audio amplifier. Hence, we are obliged to increase the value of the biasing resistor in order to secure the proper voltage on the grid of this tube. This value, in the case of the amplifier, works out to be about 2,250 ohms. The by-passing condenser in this circuit must be much higher than in the R.F. stage, because we have audio currents to consider in the plate circuit. These audio currents must not be

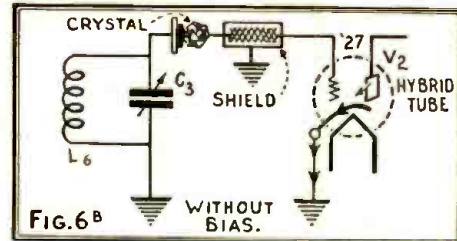

The "hybrid-tube" combination may be used without a bias, also, as shown here. Experiment will probably find the best value with any particular crystal.

allowed to impress any voltage back on the grid or bucking feed-back will once more occur. It is extremely important here; for the effect seems to be very much more pronounced—the signals being practically killed. One microfarad capacity has been found satisfactory; such condensers need not be of the best quality, as the voltages across them are extremely low.

The condition for obtaining the "C" bias and reducing the hum in the last (power) amplifier are a little different from those just discussed in connection with the heater tubes; you must remember that we are using raw A.C. on the filament of this power tube. Fig. 4 will serve to illustrate the new conditions. In the first place, the grid return must be brought, eventually, back to the middle of the filament; otherwise the alternating pulsations in the A.C. filament will be impressed on the grid—resulting in a bad hum. By returning the grid to the exact neutral center of this circuit, the back-voltage on the grid, caused from the alternating currents in the filament, is completely neutralized. We must, therefore, put a center-tapped resistor across the filament of this tube. Then, in the second place, we are interested, not only in keeping the hum from the grid, but also in placing on the grid the proper biasing potential to enable us to obtain good quality.

This is done in the manner already described. The resistor is placed between the center tap and the "B—" return. The plate current of the power tube is considerably more than that experienced in the ordinary amplifying tube; so we do not require as much resistance for a given potential bias on the grid. Thus, in spite of the fact that about 50 volts are required on the grid of the power tube, we calculate that only about 1500 ohms are needed in the plate return. This is less than the value required in the first audio am-

(Continued on Page 282)

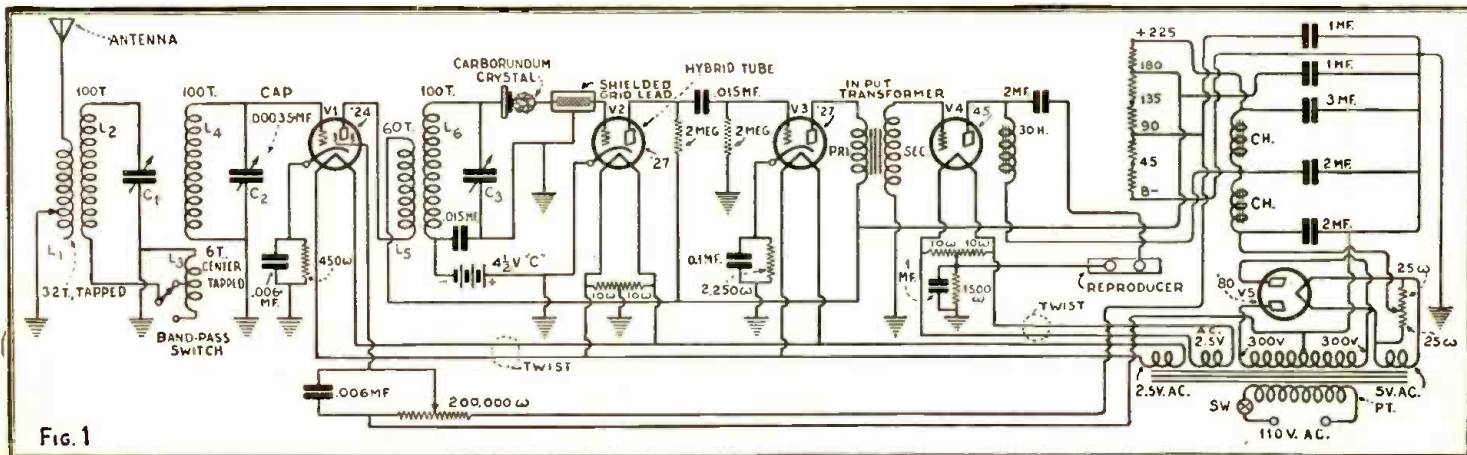

Fig. 1

The complete circuit of the A.C. model of the "hybrid-tube" receiver. By means of the band-pass "Tandem Tuner," together with the high amplification of a '24 screen-grid R.F. stage, selectivity and sensitivity are readily obtained. Constructional values are shown; it is necessary to locate the power equipment so that its field causes no hum in the receiver.

# The Radio Craftsman's Own Page

In these columns will be found letters of RADIO-CRAFT readers from every quarter of the globe. Here old friends will renew acquaintances of long standing.

## TO REACTIVATE OR NOT?

Editor, RADIO-CRAFT:

I am just in the midst of the pleasure of reading your October issue which is the first number I have seen, and I am enjoying it very much. However, I wish to register my exception to Mr. Palmer's statement in his tube article: "Reactivation of a filament is a confession of abuse, either through sheer carelessness or pure ignorance of the meaning of correct use."

As a mere experimenter, I do not care to pit my beliefs against any radio engineer's; but I do not believe this statement to be correct. I use a home-constructed four-tube; with a stage of tuned R.F. before a regenerative detector and two stages of transformer-coupled A.F. The filaments of the R.F. and the two A.F. stages are controlled by amperities. The R.F. stage occasionally gets light in volume and cranky in tuning. In such cases I invariably find (per my tube checker) the plate emission of this tube to be low, and in need of reactivation—which it gets promptly. Things are then O.K. This does not seem to check up with the statements of Mr. Palmer.

R. S. TALCOTT,  
224 Eureka Ave.,  
Wyandotte, Mich.

(Even the recital of his experience by our correspondent does not lead us to alter the judgment expressed in the article to which he takes exception; based, as it is, on the experience of all tube-laboratory engineers. A "thoriated-tungsten" filament will continue to supply electrons until the thorium is exhausted sufficiently to bring it to the end of its useful life; when rejuvenation restores functioning for but a short time. When, however, the tube is operated at a plate voltage too high—or a grid bias too low—the plate current draws too heavily on the filament emission [not plate emission, for the plate emits nothing] and the tube is temporarily paralyzed. It may then be reactivated, and this operation may be repeated several times; though the proper remedy is to correct the operating conditions, so that the tube will give more satisfactory results during a longer life. That Mr. Talcott's tube keeps requiring reactivation suggests that the circuit values should be changed, as regards this stage.—Editor.)

## EXTRAORDINARY DISTANCE WORK

Editor, RADIO-CRAFT:

I wonder if there are any fans who are interested in listening to stations on the other side of the world that operate on our own broadcast band? I have had such hopes for several years, but never realized them until last winter. I have verifications from three stations in New Zealand, and four in Australia; besides hearing other stations, of which six were in Japan. (Original verifications enclosed.—Editor.)

I have two sets which bring them in; one with five tubes and the other with six. Their success does not lie in the circuit, which is simple, but in the tubes. I use UX-199s or their equivalent as the R.F. amplifiers and detector, with a resistor to protect them from the "A" battery. The audio stages use a 201A and a 112A. I find the 199s much more sensitive in the R.F. and detector stages; they are one of the reasons for such extreme DX. Also, static does not hurt my ear drums when I am using them; as it does with 201As in these stages. Sometimes I can put a station clear across the Pacific on the loud speaker; I get them best from 1 a.m. to 6 a.m., Central Standard Time. Among those most often received are 2YA, Wellington, N. Z., and 2BL, Sydney, Australia; which I get three or four mornings of each week. They always come in during a falling barometer; but hardly ever during a rising barometer. My aerial is 100 feet long and 30 feet high; for a ground, I have four pipes driven in.

E. M. WELLING,  
Crawford, Nebraska.

(Mr. Welling will probably be besieged with inquiries for his hookup; but, as he very correctly observes, it isn't the circuit that gives such unusual results. There is no doubt that his location is an excellent one, while the same set at most points would bring in nothing beyond the Coast. As for tubes, while he finds the '99s best, it may be of interest to our readers that the finest transatlantic commercial receivers use amplifiers as large as '10s in the R.F. stages.—Editor.)

## USING OLD APPARATUS

Editor, RADIO-CRAFT:

Many of your readers have "A" eliminators and are progressing to A. C. operation; they will want to find some use for the "A" unit, or must sacrifice it. I contemplate using mine to operate two or more dynamic reproducers in one baffle. Would be very much interested in your views on this.

TOM R. ANTWIS,  
Sarasota, Florida.

(This is perfectly practicable with the dynamics which are designed for 6-volt D. C. excitation of the field coil. The later models, of course, are built with their own rectifiers to operate from the lighting current; but the method suggested offers a slight economy for the constructor who has a superseded "A" unit on hand.—Editor.)

**T**HE letters of encouragement and praise which our readers have been showering on us have been very welcome to the Editors of RADIO-CRAFT, and they take this opportunity of acknowledging the great number to which it has been impossible to reply personally, much as they would have liked to do so. This is YOUR magazine, and it will welcome every letter which expresses a definite wish for a certain line of editorial information.

We trust to make this Experimenter's page the stamping ground of those who like to follow out their own ideas and do something a little different. What have you found out for yourself that will help along other experimenters? Write to the Editor of RADIO-CRAFT and tell your story in your own words.

## A REAL "B" ELIMINATOR

Editor, RADIO-CRAFT:

Sometime ago I had been listening to a program of music from WLW and, as I was going to retire, I pulled out the plug which attached my "B" eliminator to the 110-volt line. I was using the headphones at the time and the filaments of the tubes were still burning. I was greatly surprised to find that I still heard the program of WLW, as I had not yet removed the headphones. Although the reception was very faint, it was quite distinct. Turning the dial I could get several other stations; KDKA coming in quite plain, so that I could get the announcements clearly. Of course the eliminator was still connected to the set, but it was not connected to the power line. It uses an '80 rectifier tube, while the receiver is a Zenith 4R set with three tubes. I was using a storage "A" battery.

E. R. PRINCE,

Logan Avenue, No. Parkersburg, W. Va.

(It is possible for a tube to operate with low plate current on no more voltage than an "A" battery will furnish; since the potential of the filament ranges all the way from "A+" down to "A—" and there may therefore be five volts on the plate as compared with the low-voltage side of the filament. The "Solodyne" which came out some years ago operated without a separate "B" battery.—Editor.)

## THANK YOU: WE ARE TRYING

Editor, RADIO-CRAFT:

You sure are putting out the stuff that the average fan wants. We have our radio for broadcast receiving, and it stays put; but we want to try everything new that comes out and you seem to be trying to give us the right dope.

I am in touch with about twenty fans and we all waited patiently for the first issue of RADIO-CRAFT, as we have been stung so many times subscribing to furniture catalogues (called radio magazines) that we had to be shown. When it did come out, there were not enough to go round; simply just couldn't be found in San Francisco, so we loaned them out. We all had our orders placed with local newsmen for the next number, and we are sure well pleased with it. Keep up the good work and the fans will back you up.

J. R. HARCOURT,  
San Francisco, Calif.

## A "BIG KICK" IN RECEPTION

Editor, RADIO-CRAFT:

I like this magazine; it's just the kind I wished to have, because it explains every detail in the hook-ups, and for the other good features it contains.

I built a "Candy-Box Special" short-wave set and coils, and have had good results. I listened to 2ME, Sydney, Australia, between 6 and 8 a. m., Eastern Daylight Time, on Sundays, June 16, 23, 30 and July 7. That station was doing duplex work with CGA at Drummondville, Canada; on June 30, it re-broadcast CGA, and on July 7 I heard the Thanksgiving services in Westminster Abbey, London, from Sydney. The announcer said that CGA picked up 5SW at Chelmsford and relayed it to 2ME. I have written Sydney for verification, but I am waiting for it for this occasion.

NICK GAUG,

Astoria, L. I., New York.

(There are several thrills in short-wave listening, it will be seen, as compared with ordinary broadcast DX, for the listener whose location is good and whose installation is right. The wonders of short-wave transmission have not yet begun.—Editor.)

## HOW'S YOUR GROUND?

Editor, RADIO-CRAFT:

Often in the middle of a program it is disturbed by a crackling sound which sometimes lasts for minutes at a time. Such was the case in my radio and I often attributed it to local electrical storms. However, I noticed that, whenever anyone went into one of the rooms on the second story, we would witness the same disturbance. After tracing the trouble I found that the ground was connected to the radiator in the room and the bed upstairs was rubbing against the radiator. Changing the ground to the water-pipe reduced this disturbance to a minimum.

V. K. CONCANNON,

213-34 112th Ave., Queens Village, L. I., N. Y.

## ONE OF MANY GOOD WISHERS

Editor, RADIO-CRAFT:

I wish to thank you for your magazine; I find it one of the best that can be put out, and I am telling all my radio friends about it. I am getting my copies from the news company. I shall be glad to do all I can for your magazine.

I am getting the parts for the new "A.C. Screen-Grid Peridyne" described in September RADIO-CRAFT and will build it.

JOSEPH REBELLO, Jr.,

94 Amour St., New Bedford, Mass.

(We wish that we could print all the letters of friendly co-operation that reach us; but, fortunately, they are too many in number. They are appreciated, however.—Editor.)

## AN INDUSTRIOUS EXPERIMENTER

Editor, RADIO-CRAFT:

I would like to express my gratitude at this time for your much-needed publication.

I do a good deal of experimenting, and would like to tell you of my success with a small outfit. I built a three-tube regenerative receiver without a blocking tube, until I got it working well. I used a variable tickler and found it too "ticklish"; installed a variable resistor (old potentiometer) across the tickler coil, and made things smoother.

Then I put in a blocking tube, untuned, and used different types, to find the '01A a good distance-getter, but very critical; the '71A not so good on distance, but it almost eliminated the whistle down to 225 meters. Now, I use a '22 screen-grid and CeCo detector, with 135 volts "B" on the plate of the first, and 90 on the second. The first audio stage is an '01A and the last a '12A. Finally, I did away with the original 3-circuit tuner and wound a coil with a fixed tickler.

My log shows stations from 199.9 meters to 545; I am situated about 45 miles from San Francisco and have no interference. In the winter I receive, almost every night, WLAC, Nashville. Also, while demonstrating to my friends, I have received stations every half point on the dial for five points, with surprising selectivity. No shielding is used anywhere.

I have coupled my tickler's variable resistor to

(Continued on Page 286)



# Practical Literature for Radio Readers

Available from Many Sources, and  
Giving Information That Is  
Worth Having

## Servicing

**INSTRUCTIONS FOR SERVICING RADIO RECEIVERS.** Several editions, with data for the use of different testing units. Contains tables giving the characteristics of standard receivers of the principal commercial makes, tube test data, etc. (*Jewell Electrical Instrument Co., Chicago*).

**THE DIAGNOSTICIAN.** Issued by the "Supreme Service League" of Greenwood, Mississippi, composed exclusively of owners of "Supreme" testing apparatus. Includes general and special articles, as well as supplement sheets for the "Supreme Radio Manual," with which its stated subscription of \$1.00 per year is combined.

**TUBE DATA**—The CY-324 and the CX-345. The two new tubes are the most important developments of the past two years, and these booklets, supplementing the "Cunningham Tube Data Book," which carries data on the complete previous line, are essentials to intelligent operation and experiment with the new A.C. screen-grid and the medium-voltage super-power amplifier of this season. Incidentally, the new data sheets are furnished in a smaller size with handy loose-leaf cover. (*E. T. Cunningham, Inc., New York City*).

## Custom Building

**CUSTOM-BUILT RADIO.** This, perhaps the finest book yet issued for a similar purpose, is worthy of notice for the unusually attractive illustrations in rotogravure and colors. It is worthy of its text, "The Finest Things are Hand-Made," and illustrates the possibilities of custom-building de luxe, for clients who desire cabinets to harmonize with fine interiors. (*Scott Transformer Co., Chicago*).

**THE RADIOBUILDER.** A monthly publication dealing with the products of the company issuing it, together with *Technical Data Sheets*. The issue before us describes the new line of factory-made "Silver" receivers which have been added to the kits well known to custom builders. Incidentally, the company announces that it no longer manufactures "private brands," but has concentrated upon its own trademarked products. (*Silver-Marshall, Inc., Chicago*).

## Experiment and Design

**HIGH-FREQUENCY STABILIZATION.** A brief synopsis of the history of the piezo-electric (quartz-crystal) oscillator since its fundamental principle was discovered by the Curies, and of its various discoveries and practical applications; together with information on the construction and care of this delicate apparatus, which now has so important a function in transmission and other work. (*Adam Hilger, Ltd., London, England*).

**GENERAL RADIO EXPERIMENTER.** In the July-August issue of this little magazine for the advanced experimenter, we find an article on "The Importance of Mutual Conductance in Testing Vacuum Tubes," by Charles T. Burke. It is accompanied by formulas, and circuit diagrams. A second article describes a new meter designed to measure the power output delivered by an audio-frequency amplifier, as in the case of a public-address system, "How and Why the Fader" by Horatio Lamson, discusses a new device which permits control of sound amplification and smooth change over, as from one talking movie film to another. (*General Radio Co., Cambridge, Mass.*)

## Merchandising

**THE CROSLEY BROADCASTER.** "Boy, page Aladdin!" is the heading of the first page of the Sept. 1 issue of this semi-monthly "house organ," which is illustrated by a view of the new plant of its publisher. The *Broadcaster*, unlike many other house organs, makes it a point to carry several helpful hints for dealers in each issue; as well as technical data, such as the current "Advanced Radio Course." (*Crosley Radio Corporation, Cincinnati, O.*)

**MERCHANTISE.** This is not a radio periodical; but the issue before us is devoted to another exposure of "gyp" store methods, now possible only in a large city, typical cases of substitution, misrepresentation, and downright dishonesty on the part of a chain of radio stores in Philadelphia. Fortunately, we may assume, most radio men nowadays either are honest or believe that honesty is the best policy. (*Better Business Bureau of Philadelphia*).

## Power Amplification

**THORDARSON POWER AMPLIFIER MANUAL.** This book of 64 pages carries, in addition to a list of the apparatus designed by its publisher, with circuit diagrams and values, a general chapter dealing with the design, building and testing of amplifiers, tube data, etc. It should be upon the shelf of every custom builder in these days of increasing demand for amplification to operate multiple-radio and public address systems. 25 cents. (*Thordarson Electric Mfg. Co., Chicago*).

**AUDIO-FREQUENCY TRANSFORMERS.** A booklet containing a discussion of the characteristics necessary to obtain fidelity of reproduction from an A. F. channel, of the characteristics of push-pull circuits, reproducers, etc.; and diagrams and specifications for the construction of amplifiers and power units from a single 71-type output to push-pull 50s. (*Ferranti, Inc., New York City*).

IT will be the purpose of this department to list, as it comes to hand, all literature which will be of help to the custom builder, the service man, or the amateur experimenter and set builder, from the standpoint of conveying technical and business information worthy of their reading and filing for reference. Some of the items described are issued for free distribution; and for others a small amount is charged, to limit the requests to those to whom the information will be of real value. We invite all manufacturers and distributors issuing new material of this practical kind to send advance copies to this office, to ensure its early listing in RADIO-CRAFT.

**LOUD SPEAKERS.** An engineering bulletin which analyzes the performance and characteristics of reproducers, with special reference to audio quality; and gives valuable instructions as to their selection and comparison. Unlike most commercial literature, this contains no advertising. (*International Resistance Co., "Durban"—Philadelphia, Penna.*) A companion bulletin, following it, is "Dynamic Loud Speakers," by the same writer.

## Constructional Information

**COPPER SHIELDING FOR RADIO.** This is the product of a cooperative association of producers interested in following up every possible market. The booklet contains a little explanation of the principles of shielding design; and practical advice, with diagrams, for the constructor who undertakes to be his own sheer metal worker. (*Copper & Brass Research Association, New York City*).

**WHAT SHALL I BUILD?** Like all radio editors, the writer of this book tells the constructor to choose for himself. Fifteen popular receivers are described, ranging from four tubes to fourteen; the superheterodyne type predominates. In addition, the booklet offers data on other circuits if requested. The Remler and Frost lines of parts are illustrated. (*Herbert H. Frost, Inc., Chicago, Ill.*)

## Interference

**FILTERETTES,** monthly. A small periodical devoted to methods of locating and remedying interference or "static" caused by electrical appliances and power lines, etc. This subject is one of increasing interest to service men. Free distribution. (*The Tobe Deutschmann Corporation, Canton, Mass.*)

**RMA BETTER RADIO RECEPTION MANUAL.** The purpose of this book is explained in its sub-title, "Home-Made Static and How to Avoid It." It contains trouble-shooting advice, filter diagrams, choke-coil constructional data, etc.; and was prepared by its publishers as a cooperative measure to better the radio industry by improving general reception conditions. Its distribution has been very large. Price, 25 cents. (*Radio Manufacturers Association, Inc., New York City*).

## Short Waves

**HAMMARLUND SHORT-WAVE MANUAL,** 1929. Data for short-wave receiver design, screen-grid tube circuits, list of transmitting stations, etc. Calibration curves for coils, hour-conversion chart, etc. 10 cents. (*Hammarlund Mfg. Co., New York City*).

**SHORT-WAVE APPARATUS,** Second Edition. This booklet, while more in the nature of a catalog, contains diagrams, with constants, etc., of short-wave transmitting apparatus up to ten watts, as well as receivers and operating information, instruction in the use of frequency (wave) meter, etc. 25 cents. (*Radio Engineering Laboratories, Long Island City, N. Y.*)

**NOTES ON SHORT-WAVE RECEPTION.** With an account of methods used in tuning in foreign stations on a "Thrill-Box" screen-grid receiver. (*Abbott Research Laboratories, Malden, Mass.*)

**RADIO DESIGN.** The fall issue of this meaty magazine for constructors and experimenters introduces the new A.C. short-wave "Super-Wasp" designed by the Pilot Mfg. Co., with which *Radio Design* is closely associated. The P-227 tube was designed for use as the regenerative detector of this set. The 96 pages of this quarterly, which has been enlarged, contain much in the way of wrinkles and practical hints, as well as data. 50 cents a year. (*Radio Design Publishing Co., Brooklyn, N. Y.*)

**TELEVISION—THE EYE OF RADIO.** A booklet which, without technical contents, contains a discussion of television from the side of its future commercial value. It is illustrated with pictures of the Jenkins system, including views of a home television whose design is being worked out. (*Jenkins Television Corp., Jersey City, N. J.*)

## Parts and Accessories

**BULLETIN No. 101** (of the Elkon Division, P. R. Mallory & Co.) "General Data on the Elkon Rectifier." The theory and construction of the dry electrolytic rectifier, now coming into wide use for so many other purposes besides the battery charging for which it was at first developed, are set forth herein; together with diagrams of circuits and data on the operation of the devices. (*Elkon, Indianapolis, Ind.*)

**TRUVOLT DIVIDER MANUAL.** Data on the application of resistance in power circuits to obtain varying voltages, with tables and formulas sufficient for the design of a "B" unit. 10 cents. (*Electrad, Inc., New York City*).

**THE GATEWAY TO BETTER RADIO.** A discussion of many features of set design operation, and "kinks" for the constructor and servicers. A very thorough discussion of the effects of resistance in different circuits, and of the merits of different methods of applying control with resistors of different ranges and current carrying capacity. 25 cents. (*Clarusat Mfg. Co., Brooklyn, New York*).

**AEROVOX CONDENSER AND RESISTOR MANUAL.** This is well described in its sub-title, "A helpful manual on the proper use of condensers and resistors in radio receivers and power-supply units, with detailed specifications of Aerovox condensers and resistors." Thirty-two large pages of practical data. (*Aerovox Wireless Corp., Brooklyn, N. Y.*)

**SOMETHING LOWER PRICED,** Etc. A lecture addressed particularly to the manufacturer interested in cutting costs on mass production. Devoted to a discussion of bakelite-socket construction and design, and especially the subject of tube-prong contacts. "Sixty per cent. of the service troubles developing in sets," it is stated on the authority of a manufacturer, "are due to faulty contact of sockets;" and the advent of modern A. C. tube design has made this matter more and more important. A large line of stock sockets, plugs and adapters is shown in concentrated form. (*Alden Manufacturing Company, Brackton, Mass.*)

**THE AMPERITE BLUE BOOK.** An explanation, in connection with the self-adjusting rheostat, of tube action, with characteristic curves and diagrams of a number of well-known receivers. A convenient guide for the experimenter and set builder. 15 cents. (*The Radiall Company, New York City*).

# New Radio Devices for Shop and Home

*In this department are reviewed commercial products of most recent interest. Manufacturers are requested to submit descriptions of forthcoming developments.*

## "PICKLE-BOTTLE" COILS FOR S-G TUBES

IN the set below there are a two-winding coil and a three-winding coil. (The primaries are placed at one end of the secondaries.) The former has a primary for the

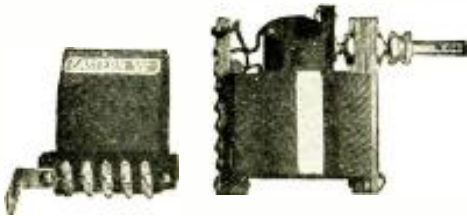

A kit of coils designed for efficient screen-grid broadcast-set construction.

aerial and ground, and a secondary which is designed to "look into" a screen-grid tube. The highly amplified output of this R.F. tube connects to the primary of the second coil unit; and the secondary of the latter to a standard detector tube (a '12A is recommended for D. C. operation). Regeneration in the detector is then obtained by means of the tickler coil provided for its plate circuit. All coils are wound in the same direction.

The constants of this "low-loss" coil combination are as follows: No. 22 D. S. C. wire used throughout; antenna primary, 10 turns, tapped at the 5th for closer tuning; second coil primary, 30 turns tapped at the 10th; both secondaries, 58 turns; diameter of primaries, 2 inches; diameter of secondaries, 2 1/4 inches; diameter of tickler coil, 1 inch; tickler coil has 30 turns; tuning capacity, .0005-mf. For circuits requiring various primary impedances, ten, twenty or the full thirty turns of the second primary coil may be used, to give the optimum performance.

The list price of this matched coil combination, made by the Eastern Coil Co., Brooklyn, N. Y., is \$7.50.

## THE "E-Z WIRE STRIPPER"

A CLEVER device, the "E-Z Wire Stripper," is being offered by the Pyramid Products Co., of Chicago and Los Angeles. Its particular merit lies in an extraordinary ability to strip heavy insulation from wires rapidly and cleanly.

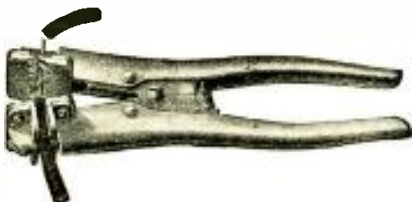

The automatic operation of these pliers makes stripping heavy wire an easy job.

In the head of this stripping plier are set two independent components, operated by the hand-grips; one comprises a cutting blade which moves toward and away from a fixed blade, and the other a serrated gripping surface which moves toward and away from a fixed gripping surface.

The wire is placed in the slot of proper size and the plier is grasped in the hand. The result is that the two gripping surfaces close on the insulation; and the two cutting surfaces clip through the insulation, but do not nick the wire. Continued pressure causes the gripping surfaces to move away from the cutting

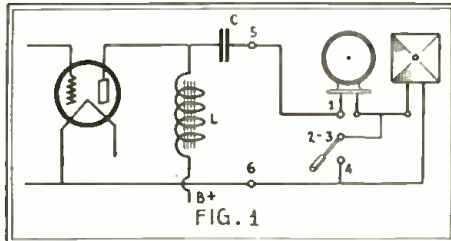

The "Speakerelay" may be used in this manner to balance reproducer quality.

edges, thus stripping the cut-through insulation from the wire.

If it is so desired, the wire may be clipped entirely through, by placing it between two cutting edges provided, instead of in the nick intended only for insulation-stripping.

This tool is ruggedly built, easily oiled; the cutting and gripping surfaces are replaceable and may be resharpened; and it may be easily

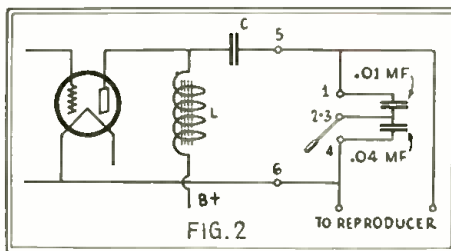

This connection of the same device permits the most pleasing "tone modulation."

tooled to fit any particular wire condition. It is heavily nicked, and weighs twelve ounces. The length is 7 1/4 inches; the price, \$5.00.

## "MASTER TUNING SELECTOR"

TO the growing group of station-selecting devices has been added a product of the Master Engineering Co., Chicago, Ill., called the "Master Tuning Selector," which is illustrated in these columns.

By means of a rack-and-pinion movement, the rotary motion of the regular tuning knob is transformed into a lateral motion. This lateral drive carries a pointer across a "full-vision" scale on which are indicated, by means



Your radio dial is your log; settings are obtained immediately at predetermined points.

of celluloid markers, stations up to seventeen in number. These settings may be made exact for those stations by the regular method of tuning; and then the exact adjustment thus found is indicated for future use.

In operating the "Master Tuning Selector," the usual procedure is to turn the volume knob to minimum, then the selector knob until the pointer indicates that the desired station setting has been reached; and then bring up the volume to the desired level. This method is quiet and avoids noisy blasts, howls, and similar tuning annoyances.

Only a few minutes are required to attach the instrument to almost any receiver.

This item lists for \$3.75.

## THE "SPEAKERELAY"

UNDER this name the Fisch Radio Company, Bronx, N. Y., are offering a simple little "accessory" to the radio set. It is essentially a glorified single-pole double-throw switch; this will explain the circuit arrangements which appear in these columns. The points from 1 to 6 in the accompanying diagrams are the connections of the "Speakerelay. In Fig. 1, the arrangement permits the use of either one or both reproducers. If one is low-pitched and the other high-pitched, interesting combinations may be obtained; their quality depending upon the particular program and station being heard.

Another and less obvious arrangement, Fig. 2, produces a "tone-color" effect by shunting a reproducer with the two capacities shown.

(Continued on Page 274)

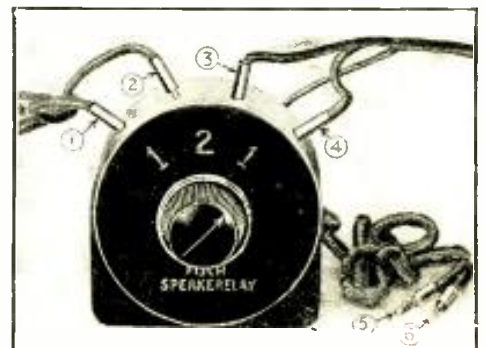

Appearance of the "Speakerelay" selector switch, uses of which are shown in Figs. 1 and 2.

# Solving the Problems of City Aerials

*The RCA "Centralized Radio" System Enables All Receivers in a Building to Operate from One Aerial at Once.*

**F**EW people, except those directly concerned with the practical work of installing radio receivers in large cities, can realize the serious difficulties, of obtaining suitable antenna connections in a "multiple dwelling" or apartment house, which have arisen as a result of the universal interest now taken in radio reception. A look, however, at the roof of many a building of this kind will show that it bears a literal "forest of aerials," as do its neighbors on every side. As far as the eye can perceive, in all directions, the copper strands extend. The service man becomes adroit in navigating the maze; the installer must be another Sherlock Holmes to locate a possible point at which to fasten "Just one more wire" to serve another radio listener.

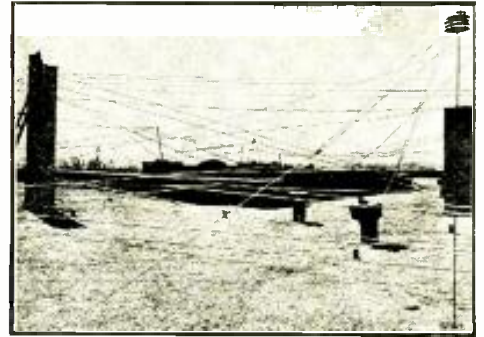

Typical view of a New York City roof, with "independent" (yet interfering) aerials.

### The R.C.A. "Centralized Radio" System

To serve the greatest number of receivers with maximum efficiency, the Radio-Victor

Neatness of equipment and improved appearance of building;

High efficiency of signal pick-up and transfer;

Low cost per outlet group.

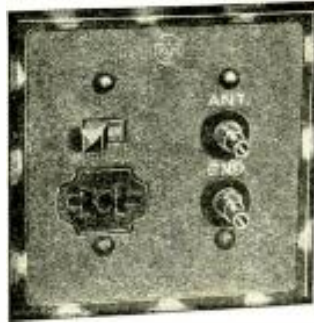

An "RFO" outlet mounted in the wall of a room furnishes all connections for a receiver.

### Details of the System

A well-designed aerial, properly installed and lightning-protected, has its lead-in connected to an aperiodic (untuned) stage of radio-frequency amplification (called the "central coupling and plate-supply unit," or "RFC") located as close to the antenna as is physically possible; this in most instances, means placing this shielded unit in a pent-house on the roof. One '80 and one '26-type tubes are used in the "RFC"; the "B" eliminator for the "RFC" and one to eight "RFXs" is also incorporated in this unit. One aerial will "feed" up the eight "RFC" units.

From the "RFC" runs the three-wire No. 19

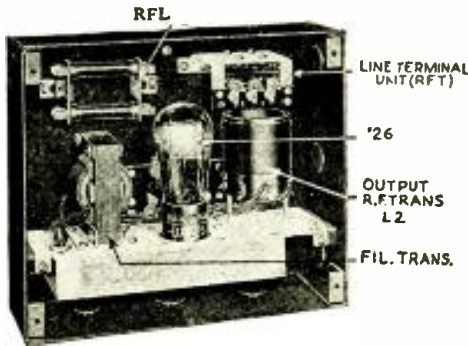

The "RFX" or outlet unit feeding the individual receiver. The "RFT" unit appears only in the last "RFX" on the line.

Corporation of America has developed its "Centralized Radio" system.

In this design the signal is picked up by a single aerial and brought to room outlets, each of which has antenna and ground posts

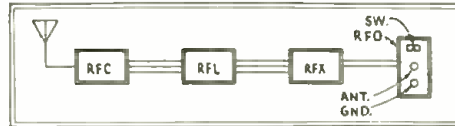

The system, in the order of its operating units.

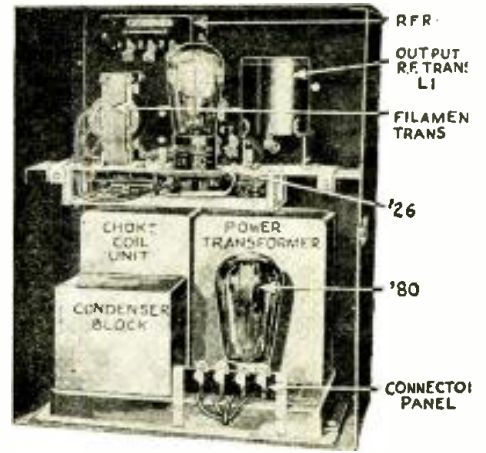

The "RFC," or first unit of the system supplies plate current also for coupling units.

to which any standard radio set may be connected.

This system of program pick-up and transfer has many advantages over the ordinary arrangements, as follow:

Total absence of inter-action between receivers;

Elimination of electric-equipment interference, ordinarily picked up by the lead-in;

Ease of installation and maintenance;

No moving parts;

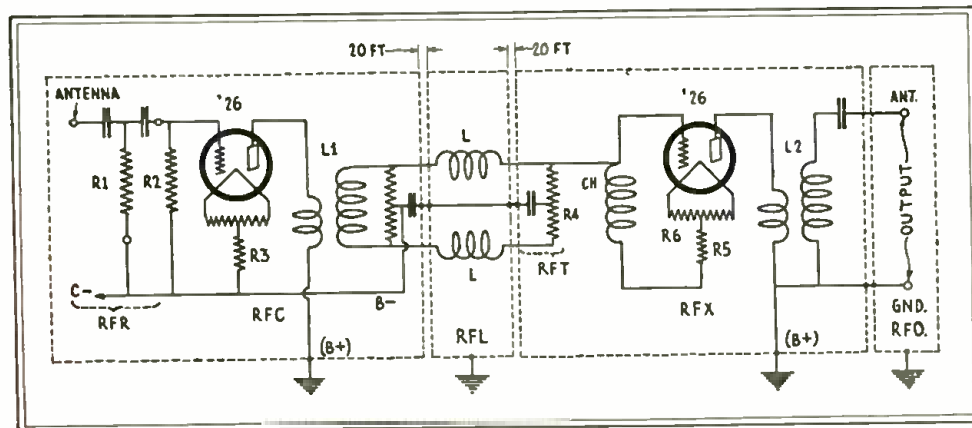

Schematic circuit of a "Centralized Radio" system. The "RFC" within dotted lines at the left may be one of eight connected to one aerial; through "risers" containing "RFL" loading coils, it feeds up to ten extension coupling units, or "RFXs," like that at the right. Each of the latter is connected to one receiver through an "RFO" outlet in its room.

"triple twisted," rubber-covered R.F. transmission line, which also carries "B" potential from the "RFC"; this line is called a "riser."

At every twenty feet, there is placed in this "riser" a "loading-coil unit" ("RFL"); the purpose of which is to prevent the radio-frequency current being by-passed to ground. (Such coils often consist of 100 turns of No. 32 enameled wire on a half-inch bakelite form; two forms spaced about 1 1/2 inches being required.)

Next follows the "extension coupling unit," or "RFX"; it is an aperiodic stage of radio-frequency amplification using a '26 tube. Its "B" potential is taken from the middle lead of the "riser." One "RFX" is required for each radio set; one riser will feed ten "RFXs." (Therefore, one aerial will serve for eighty radio receivers. An additional aerial is required for each group of eighty outlets.)

(Continued on Page 282)

# The Development of the Modern Sound Reproducer

*The Combination of the Old Principle of Multiple Diaphragms with that of the Electrostatic Speaker Has Made Possible a Remarkable New Design.*

By OSCAR C. ROOS

MUCH interest has been aroused in the radio industry by the proposed new electrostatic reproducers, and especially among the manufacturers who desire a product that will compete with the more complicated electrodynamic unit; as well as among the dealers who wish an apparatus capable of doing all that the higher-priced dynamics can accomplish, yet built to sell between \$35 and \$40, instead of twice that sum.

Leaving aside reproducers which employ the principle of *magnetostriction* in their operation, it may be said that there are now being developed two types of electrostatic reproducers which are in fidelity of tone superior to anything previously available, and capable of giving, with increased size, volume sufficient for the largest theatres.

### Perfection in the Laboratory

It may be of passing interest to state that the most perfect of all reproducers is at present a mere laboratory curiosity, as in its present form it is yet unsuitable for commercial distribution. This is the "glow-cushion," or reversed "glow-microphone," under investigation in Germany by Dessauer and Brenziger, as well as in England, and in the American laboratories of the Westinghouse company.

The "glow-discharge" microphone consists of three electrodes, 1/4- to 1/8-inch in diameter, separated by about 1/16-inch of air through which a high-tension electric discharge is maintained (Fig. 1). The air waves caused by sound change the resistance of the "glow," and thus create ripples in the direct-current

flow; these ripples are amplified in the usual manner. The advantage obtained is that the glow, unlike a mechanical diaphragm, has no inertia or natural period, and responds instantly to all impulses; but the instrument is far too sensitive for use under ordinary conditions.

The "glow-reproducer" reverses the "glow-mike's" action, as a diaphragm reproducer does that of the ordinary microphone; it has a *weightless cylinder* of glow-discharge in open air, under a direct-current voltage of 3,000 to 20,000; and the diameter of the glow varies with the audio modulations imposed on this current, creating sound waves. Unfortunately, it will be seen, this is not yet a commercial possibility (due to the potential required). Its construction is diagrammed in Fig. 2.

### Early Reproduction Experiments

We may begin advantageously by considering the small electrostatic telephones used as headphones in France *a generation ago*, and abandoned because of their lack of sensitivity. (Two stages of A. F. amplification would have done the trick, but amplifiers were not then available.) These diaphragms were small

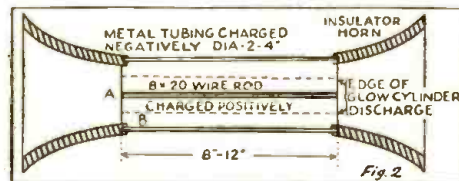

"Glow Discharge" loud speaker; "B" voltage 3000-20000 volts.

### "Piston" Action in Diaphragms

There are two other ways, speaking generally, of creating sound waves electrically, and each has its good and its bad points. First, the small diaphragm such as employed with

movable membranes, 1 1/2 to 3 inches in diameter, and gave out weak but distinct reproductions of the transmission; they were satisfactory for telegraph receivers of high-power "buzzes" but did not supersede the printing

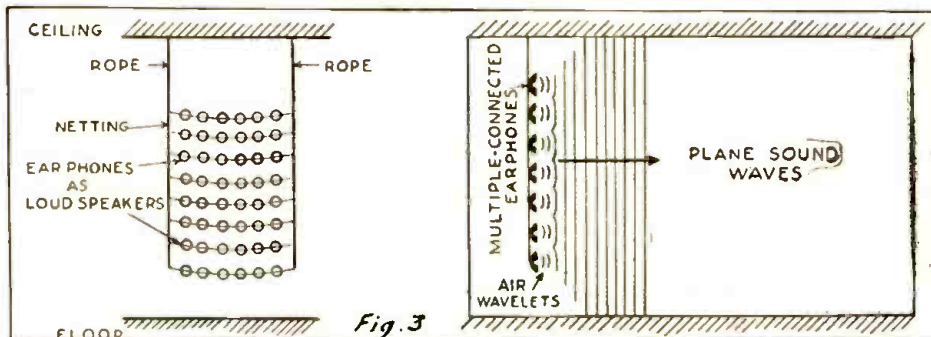

Fessenden's early experiment using a bank of ear-phones to give a plane sound wave in an auditorium.

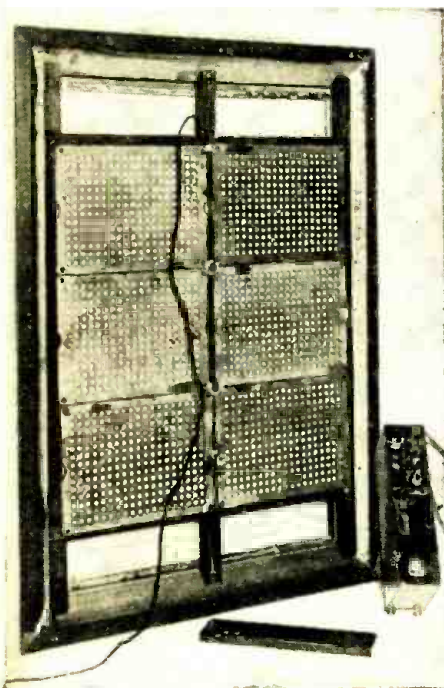

Fig. A. Rear view of a commercial reproducer showing the parallel-connected condensers and the high voltage D.C. supply. (Photo courtesy Columbia Woodworking Co.)

horns; and, secondly, the large or cone diaphragm driven mechanically from its center with a piston motion.

The electrostatic loud speaker, it is true, generally employs a flat surface as developed by German designers like Vogt and Massolle, rather than a cone; but the flat diaphragm may be considered as a flattened stiff cone, and will exhibit even more piston action. That is, the shape of a cone helps it to remain rigid while it is moving at low frequencies; and the electrostatic diaphragm as designed by Massolle vibrates in even greater degree with a large portion of its surface moving always together, parallel to itself. Unfortunately, this ideal piston action *cannot be maintained at high frequencies* with any large diaphragm, no matter how driven.

After analyzing the behavior of both the horn and the cone diaphragms, we shall see how they act in *multiple*; and will then more readily understand how a combination of them will advance reproducer design, especially where the use of the baffle board is mechanically a disadvantage. In fact, the presence of the latter is today the grave drawback of high-powered apparatus; though it is not absolutely essential, as the author will show in a later discussion.

receivers. From these we may note developments, not of the electrostatic phone, but of the diaphragm.

The horn came into popularity with the original dictating machine; diaphragms as small as 1/2-inch (in diameter) were used, but the average was about an inch. The horn had resonance points, as well as a megaphone ef-

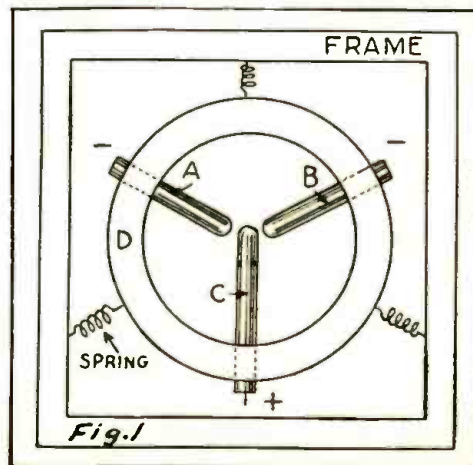

Reversed "Glow Discharge" speaker used as a "Mike."

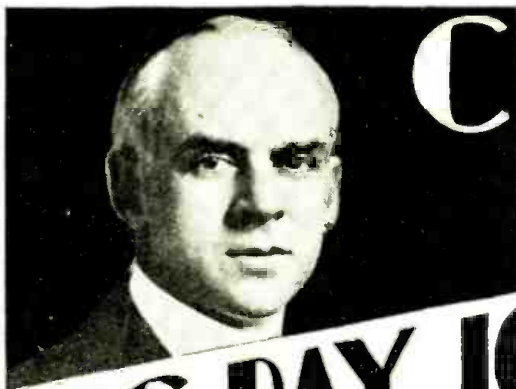

# Cooke Trained Men get the -

## BIG PAY JOBS

# in ELECTRICITY

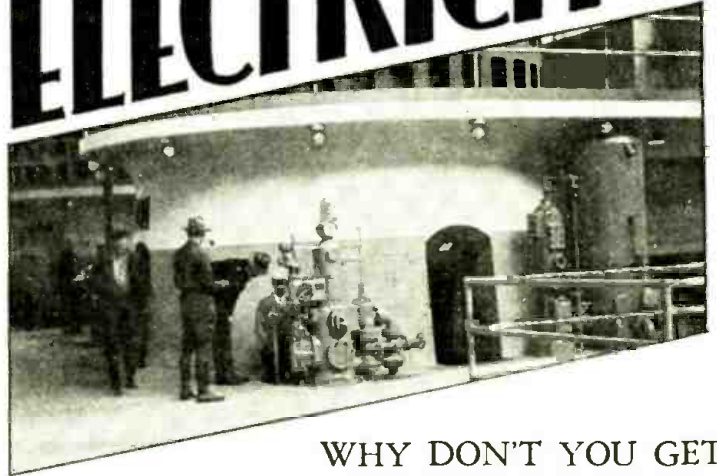
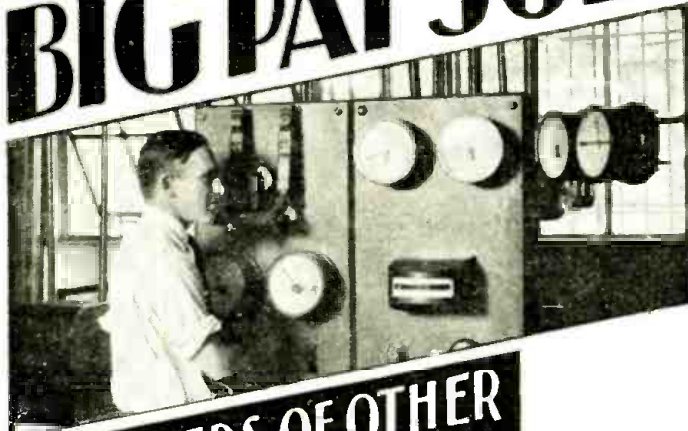

### HUNDREDS OF OTHER MEN, TOO, say COOKE TRAINING is BEST

### WHY DON'T YOU GET INTO ELECTRICITY, TOO?

It's today's great Opportunity for you and every other man who is sick and tired of struggling along on small pay. Hundreds of "Cooke Trained Men" who were no smarter than you when they started now make \$3,000 to \$5,000 a year—and some even more.

#### Learn At Home In Spare Time

Learn with the famous L. L. COOKE "Work Sheet and Job Ticker" Method. It's simple, it's thorough, it's practical, it's just like actual shop experience, yet it's all done right in your own home with the Big Complete Outfit of Tools and Apparatus given to you without extra charge. And it's done in your spare time, without quitting your present job or losing a single hour's pay.

#### Previous Experience Not Needed

You don't need previous experience—you don't need higher education to learn Electricity the L. L. COOKE Way. If you can read and write, that's enough. This great Training is amazingly simple and clear. There's nothing like it anywhere. It's the Training with hundreds of successful graduates: it's the Training that has put many men on Easy Street; it's the Training for you.

#### Get Started—Mail Coupon

"Cooke Trained Men" are the "Big Pay Men" everywhere. \$60 to \$100 a week is what many of them are making. That's the kind of a job for you. Get started under the famous L. L. Cooke Money Back Agreement. Act today to increase your pay. Send coupon for Big FREE Book, "Secrets of Success in Electricity." Mail the coupon now.

**L. L. COOKE SCHOOL OF ELECTRICITY**  
Dept. 309, 2150 LAWRENCE AVENUE, CHICAGO, ILL.



**\$350 a Month Now**

"Am now getting \$350 a month and traveling expenses, thanks to your Course."  
Chas. L. Burnside, Belle Fourche, S. Dak.



**Earns \$11 a Day**

"Am now making \$11 a day in Electricity. Four pay boosts for me since enrolling."  
R. E. Brown, 621 Waverly, Houston, Tex.



**\$80 a Month Raise**

"Boosted my earnings \$80 a month in 5 mos. I am \$1000 a year better off by taking your Course."  
Martin Heriman, Box 598, Drumheller, Alta, Canada.



**\$90 a Week Now**

"\$90 a week is my pay now. Not had for a 20 year old boy. Earned \$15 a week when I enrolled."  
A. J. Curtis, 683 Capitol Ave., Atlanta, Ga.

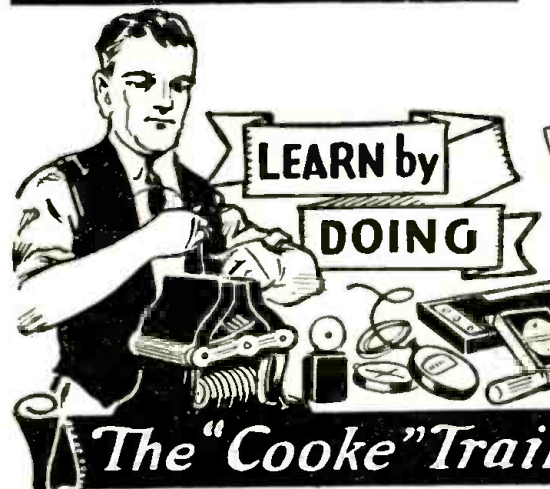

### FREE BOOK COUPON

L. L. COOKE SCHOOL OF ELECTRICITY  
Dept. 309, 2150 Lawrence Avenue, Chicago, Ill.  
Send me FREE and prepaid, your Big Book "Secrets of Success in Electricity," and your Money Back Agreement with all details about your Home Study Course in Electricity.

Name \_\_\_\_\_  
Address \_\_\_\_\_  
City \_\_\_\_\_ State \_\_\_\_\_  
Residents of Canada send coupon to R. A. Farrow, Special Representative, 7 Medbury Lane, East Windsor, Ontario, Can.

## The "Cooke" Trained Man is the "Big Pay" Man

fect, to distort the effect on the human ear which is a "non-linear" sound detector and responds with different degrees of efficiency under strong impulses than under normal sound intensities. There was little, therefore, to be done with the horn except to give it an ex-

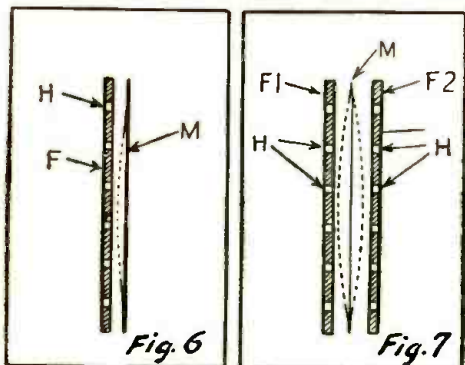

Left—General type of unilaterally-driven condenser-speaker such as "Statophone" made in Germany or "Kylectron" made in America, showing position of moving diaphragm under "B" voltage. Right—General type of bilaterally-driven condenser-speaker, such as Oscilloplane made in Germany.

ponential curve to obtain even propagation of sound. Even after this had been done, the "barrel" effect remained, and it is only in late years that attempts have been made to compensate these acoustic resonance points by shunting the "motor" unit driving the diaphragm with circuits tuned to audio frequencies—sometimes as high as seventeen in number. This method of leveling off sound "peaks" is obviously not attractive from a commercial standpoint.

In the opposite course of development, experimenters (Pathé, Lumiere, Brown, Hopkins and others) went from the small diaphragm, which acted more or less as a piston, to a large stiff diaphragm, cone-shaped to increase its rigidity, and acting as a very short, wide-angled horn. This still acted as a piston up to the "change-over frequency"; above which most of the energy is present in the form of waves in the diaphragm, theoretically radial, but in practice irregular figures arranged fan-wise around the cone, in patterns theoretically duplicating each other.

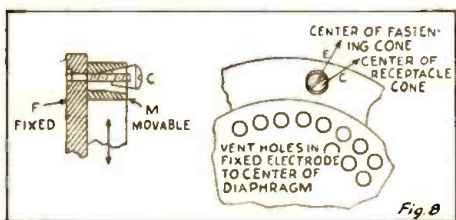

One of several different schematic arrangements by which a metal foil diaphragm may be stretched radially by variable mechanical adjusters. Compare method of tightening tympani or kettle-drums in orchestra or "banjo."

As more power was used, the effective "change-over" frequency was lowered and so, when the super-dynamic was used with more than 800 volts on the plate of the output stage, it became necessary to make the moving system lighter and yet stiffer—the latter characteristic in all cases most important. The increased lightness made easier instantaneous damping; which is absolutely necessary to avoid "blasting" and give fidelity because amplitudes, following a musical or speech sound-curve, change in intensity from 1 to 99% in a hundredth of a second!

### Early Electrostatic "Speakers"

The next practical development of the piston diaphragm was the circular plate of the

electrostatic reproducer, in which every part of the diaphragm, which ranges from six inches to six feet in diameter, is subjected to the same pull. Yet it does not move as a flat piston unless the attracting plate is cone-shaped and concave toward it; thus making the pull least at the center and progressively greater toward the rim. Even here there is a change-over point; which may be raised in frequency to any desired extent by stretching the diaphragm radially, short of rupturing it.

This stage of development is shown in the forms known as the "Statophone" or "unilateral," with "single displacement" from original diaphragm position (Fig. 6), and the "Oscilloplane" or "bilateral" with "double displacement," as in Fig. 7. We shall later refer to the former in connection with a possible development in combination with the other family of speaker diaphragms—the "fly's eye" or better, "mesh-unit" type.

### Multiple Diaphragms for Volume

The development of the last named grew out of the use of several reproducers in "series-multiple" arrangements. Fessenden did this back around 1904 and demonstrated the advantage of a large "flat" wave of sound over a spherical wave to distribute energy in an auditorium more evenly and with less acoustic distortion. For many years the im-

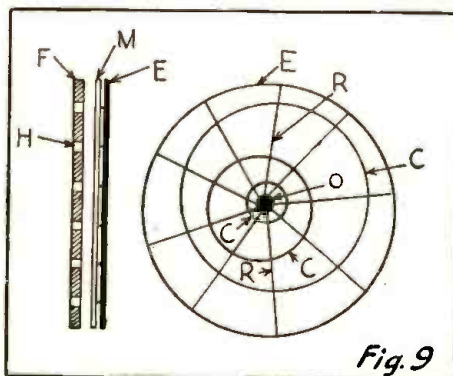

Method employed to prevent radial vibrations producing concentric zones of reinforced vibrations in unilateral E. S. L. S. The surface is touched eccentrically by damping circles—c-c-c.

plications of this experiment (Fig. 3) remained unused and it was not until about 1922 that an English publication suggested that a closed room may be more agreeably filled with music from many sources than from one. (This has no relation to the "binaural" effects which have been since used to give a doubtful illusion of the position of the listener in the midst of the actual studio.) The suggestion is based on the well-known fact that, in a closed space, the volume or density of sound is increased by the use of several reproducers, and the sound is noticeably strengthened in locations where it would otherwise be weak. The drawback is that there are always developed in the room a set of points—different for each frequency—where

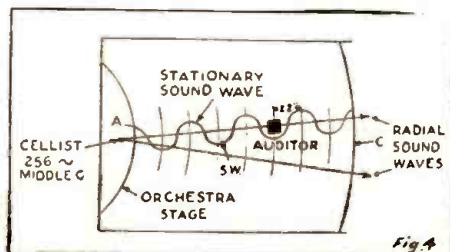

Stationary sound waves producing reinforcement and annulment on one cello tone—middle C—every half wave—22 inches—outwardly from stage. A is player; C, the reflecting surface.

the treble or higher notes from separate sources must interfere with each other. Every listener who observes carefully in an auditorium with a hemispherical sound reflector, on a concert stage, recognizes that at certain seats in the orchestra and lower mezzanine there are such strong reinforcements of certain notes, with any given orchestral "setting," that the sounds seem to come to the listener from a source a foot away, instead of seventy or so.

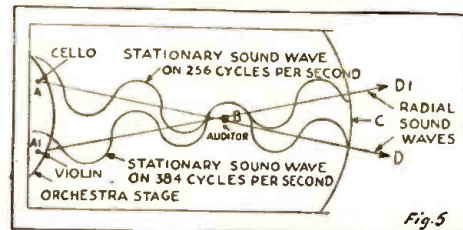

The production of "Tartini's tones" is illustrated above.

### Interference of Sound Waves

The reason is indicated in Fig. 4; since sound travels at a speed of about eleven hundred feet a second, the length of the wave produced by a musical instrument sounding "middle C" is little more than four feet. If such a wave is directed against a wall, and reflected, the reflection encounters sound waves created later from the same instrument; and it is possible that "stationary" or "standing" waves will be set up. We may have also "diffraction" patterns, showing points of sound reinforcement at right angles to the former lines, for the same note; and finally, very strong tones of simple frequency ratio (such as 3 to 2, for their fundamentals) give beats or "Tartini's tones," the principle of which is illustrated in Fig. 5.

Thus we may have interference of two kinds—on the same note or on different notes; in the former case the action may take place without the presence of a reflector. When we ask why listeners are not more annoyed than they are by these phenomena even in the dis-

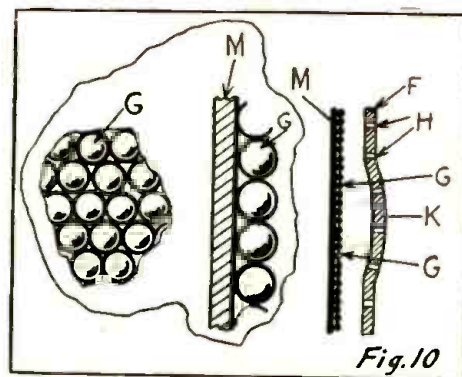

An early form of unilateral speaker, using multiple grains embedded in a movable diaphragm. The latter is made to move parallel to itself by the "bulge" K, in the fixed electrode F.

tortion of single tones—let alone the whole gamut—we see that it is because of the very complexity of the actions; when the whole range of tones is used, so that no one stands out during a performance, the oddities are not so apparent. These considerations apply only to notes which are perceptibly prolonged and, as this is the exception, not the rule, in the treble—we are still further freed from worry over the theoretical defects of a multiple-diaphragm system planned to give better sound distribution over a small auditorium.

Fessenden endeavored with more or less success to produce a plane or flat-front wave from

(Continued on Page 283)



# What Radio Design and Radio International Guild Offer the Radio Minded!

*Here is what you get for 50c per year . . .*

**FIRST** You will receive immediately the current number of *Radio Design*. This issue contains the latest up-to-the-minute construction articles (including the sensational A.C. Super-Wasp), short-wave data, radio in aviation, etc., written by engineering authorities—Robert Hertzberg, Robert S. Kruse, David Grimes, John Geloso, Zeb Bouck, and Alfred A. Ghirardi.

**SECOND** You will receive three additional quarterly issues, each one crammed from cover to cover with the very latest developments, hot news published while it is news, straight from the laboratory by the self-same engineers who do the actual work.

**THIRD** You will become a member of the Radio International Guild, receiving, upon your acceptance, a membership pin, certificate and card, giving you the benefits of Guild Membership. The Guild is a world-wide organization of Radio Engineers, Custom Set-Builders, Experimenters and Advanced Students.

*Space does not permit enumerating all the benefits the Guild offers, but a descriptive folder will be sent upon request.*



**Take advantage of this Unusual Offer**  
**Return the Coupon NOW**

**Mail Today**

RADIO DESIGN PUBLISHING Co.  
 Dept. D-2, 103 Broadway, Brooklyn, N. Y.

- I enclose 50c. coin (or stamps). Send me *Radio Design* (4 quarterly issues) and enroll me as member of Radio International Guild without extra cost, as per above announcement.
- Send me without cost or obligation literature concerning *Radio Design* and Radio International Guild.

Name .....  
 (Please Print or Write Plainly)

Address .....

City ..... State .....



# INFORMATION BUREAU

**SPECIAL NOTICE TO CORRESPONDENTS:** Ask as many questions as you like, but please observe these rules:

Furnish sufficient information, and draw a careful diagram when needed, to explain your meaning; use only one side of the paper. List each question.

Inquiries can be answered by mail only when accompanied by 25 cents (stamps) for each separate question. We cannot furnish blueprints or give comparisons of the merit of commercial products.

The reader asking the greatest number of interesting questions, though they may not be all answered in the same issue, will find his name at the head of this department.

Highest for the current month: E. R. PRINCE with 5 interesting questions.

### "CHARGED" PANEL—"BLAIR" CIRCUIT

(33) Mr. Fred Bower, Hastings, Mich.

(Q.) Is it possible for the metal panel of a receiver such as the Freshman "Masterpiece" to become "charged"; so that a shock is felt when the panel is touched?

(A.) If the "B+" of the receiver becomes grounded to the metal panel, a shock will be felt when the panel (or chassis) and any instrument connected to the "A" circuit are touched simultaneously. The solution is to locate the point at which the "B" circuit is grounded and "clear" the ground. A simple way to do this is to connect an old headphone in series with the "B+" lead, where it comes out of the current supply unit. Upon completing the circuit through a lamp, by bridging the lamp from the panel to the "A" circuit, a click will be heard. This continuity click will disappear when the grounded instrument has been located by the process of removing wires, one at a time, from panel-mounted instruments.

(Q.) Please print the schematic circuit of the "Blair" receiver. This is a resistance-capacity-coupled receiver made some time ago by the Blair Radio Laboratories.

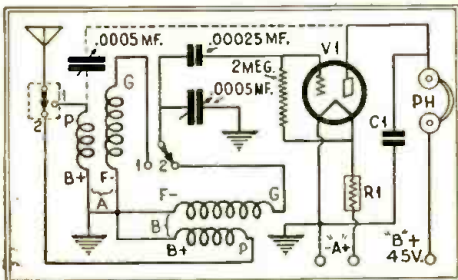

(Q.34) A single arrangement to match R.F. transformers. Long-wave (I.F.) transformers are under test above.

(A.) This schematic circuit appears in these columns. The exact values of the parts used are not available, but they are approximately as indicated. The radio-frequency transformers and variable condensers may be any standard equipment. Many variations of this circuit are possible; for instance, the inclusion of tubes of high-plate-impedance (such as the '40), in the resistance-capacity-coupled stages. Also, a fixed condenser of about

.000125-mf. in the antenna lead will greatly increase selectivity. Circuit oscillation is controlled by the rheostat in the filament circuit of the R.F. stages.

Jack J1 is for headphones, and J2 is for the reproducer.

Condensers C4, C5 and C6 may be .001-mf. Resistors R4, R5 and R6 may be 100,000 ohms; if type-'40 tubes are used as V4 and V5, resistors R5 and R6 may have a value of about 250,000 ohms. Resistors R7, R8, and R9 may be about 1 megohm; if V6 is a power tube, R9 may be 250,000 to 500,000 ohms; with a "C" bias of the proper value to balance the "B" potential applied to the plate of the power tube.

### "STROBODYNE"—R. E. 29—MATCHING INTERMEDIATES

(34) Mr. W. A. Beavers, Washington, D. C., and Mr. Everett M. McIntyre, Bridgeport, Conn.

(Q.) What is the intermediate frequency used in the Lacault "R. E. 29" receiver?

(A.) This frequency is 120 kilocycles.

(Q.) Are the same intermediates used in the "R. E. 29" receiver as were used in the "Screen-Grid Strobodyne;" and if so, where may they be obtained?

(A.) "Strobodyne" intermediates may be used in the R. E. 29; we believe they are obtainable from the Estate of R. E. Lacault, 1931 Broadway, N. Y. C.

(Q.) How can a set of home-made intermediates be matched?

(A.) It is presupposed that the design is approximately correct for the desired frequency. The problem, then, is not to match the coils exactly to a given frequency, but to match one set of coils to the other. The best method involves the use of a calibrated, A.F.-Modulated, R. F. oscillator. Its output is transferred to a detector tube, the intermediate-frequency transformer being introduced between the two units. Maximum deflection on a milliammeter indicates resonance; which is obtained by varying the number of turns on the secondary. Varying the adjustment of the long-wave oscillator until the meter indicates a current will show whether there are too many or too few secondary turns.

A more simple method is to connect antenna and ground to the primary winding, and a detector tube to the secondary; one side of the coil connecting to the grid condenser and leak, and the other side to "A+." A pair of headphones, shunted by a .001-mf. fixed condenser, are connected in the plate circuit of the detector tube. A .0005-mf. variable condenser is connected across the secondary coil and

varied until a spark signal is heard; if there is no spark signal within this range (2498 meters) a .0005-mf. variable condenser may be connected from detector plate to antenna, and varied until there is

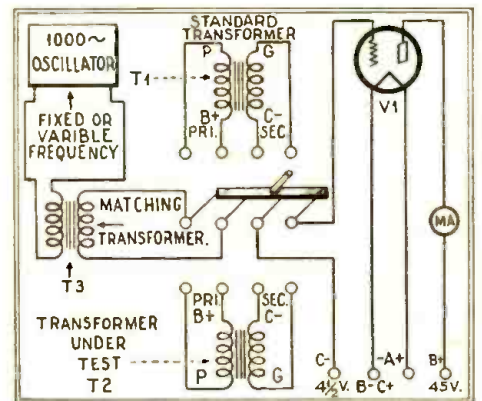

(Q.35) Arrangement used in a manufacturer's laboratory, to determine the relative value of A.F. transformers. A tuning-fork oscillator is shown.

circuit oscillation (to obtain this oscillation it may be necessary to reduce the capacity of the fixed condenser in shunt with the headphones). When a whistle is heard, as the beat-frequency between a CW signal and the circuit under test becomes audible, the reading of the variable condenser in shunt to the secondary is noted, and the second intermediate-frequency transformer is substituted for the first. The shunt condenser is again varied until the same signal is recognized. Then, turns are removed from (or added to) the secondary coil until the variable condenser's reading is exactly the same as it was when the same signal was heard with the first transformer in circuit. This is a very accurate method; the only requirements are care and common sense in applying it. In this arrangement, a code station is commandeered to supply the A.F.-modulated R.F. long-wave signal (the spark signal); or the R.F. signal may be the code transmissions of the C.W. station; the A.F. modulation being obtained by the heterodyne method as mentioned above.

To facilitate rapid comparison, a circuit, shown in these columns, has been developed.

(Continued on Page 285)

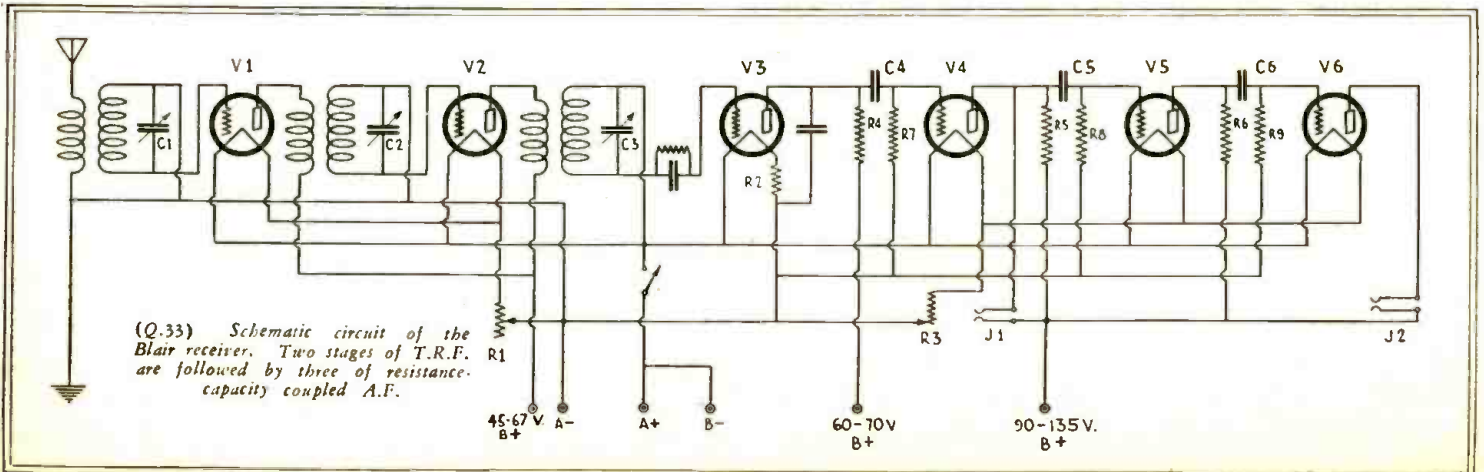

(Q.33) Schematic circuit of the Blair receiver. Two stages of T.R.F. are followed by three of resistance-capacity coupled A.F.



# WHOLESALE PRICES

## For Dealers, Service Men, General Repairmen and Set Builders!

**F  
R  
E  
E  
C  
A  
T  
A  
L  
O  
G**



Our new, HUGE LARGER PAGE SIZE (8" x 10 1/2") WHOLESALE CATALOG No. 19, 2nd Edition, enjoys the enviable distinction of being universally accepted by the RADIO TRADE in the same manner that a school treasures the Dictionary and Encyclopedia Britannica—or the home, the Bible and Almanac!! Those "in the know" regard our catalog AS THE OFFICIAL ORGAN OF THE 1929 RADIO SEASON!!!

This FREE CATALOG is literally a most valuable ENCYCLOPEDIA—YOU cannot well afford to be without one—and, you do not have to. Your request for one is all that is needed! In these many years we have been in the Radio Mail Order Business, we have learned to GAIN AND RETAIN THE GOOD WILL OF OUR CUSTOMERS. In this, our DETERMINED GOAL, RADIO SPECIALTY COMPANY OFFERS TO SHIP PRACTICALLY ALL ORDERS IN FROM 6 to 24 HOURS—OFFERS YOU 100% MERCHANDISE ON A STRICT MONEY-BACK BASIS IF NOT SATISFIED—AND OFFERS YOU ALL MERCHANDISE AT ABSOLUTE ROCK BOTTOM NET PRICES!

Our Catalog Lists More  
**Completely Assembled  
All-Electric A. C. Receivers**  
than any other Radio Catalog!

Available in chassis form, or mounted in table or console cabinets, with and without built-in loud speakers.

**OUR ROCK BOTTOM NET PRICES FOR THESE SETS WILL ASTOUND YOU!**

In this new catalog there are also listed large assortments of CAMERAS, HOUSEHOLD ELECTRICAL APPLIANCES AND ELECTRICAL TOOLS OF EVERY DESCRIPTION.

### HERE ARE TWO OF OUR BIG BARGAINS

Order From This Page—Send Money Order—Check—or Postage Stamps

#### RASCO REPLACEMENT AUDIO TRANSFORMERS

Can be mounted in either of three positions, that is, lying down, or standing up with the core parallel with the base on which it is resting, or standing up with core perpendicular to the base. Other replacement transformers can only be mounted two ways. There are six specially designed feet to provide the most convenient

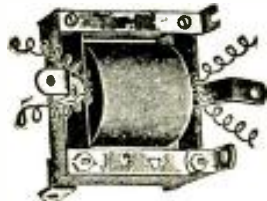

choice of mounting, and any of them can be removed at will, should you so desire. Thus, it is logical to conclude that our Replacement transformers can be installed in ANY receiver, either custom or factory built, no matter how small a space there may be available, whether such mounting is to be above, or beneath, a sub-panel, or baseboard. The coils themselves are of the first quality, and are only found on the most costly Transformers. The core is the highest grade silicon steel, and of ample proportions. A happy combination of electrical values in both the core, and coil, assure maximum

amplification possibilities—more than sufficient volume, yet with no trace of distortion! The silicon steel stampings are very rigidly bolted together by a generous size bar which is attractively nickel plated. 2 1/2 in. long by 1 1/2 in. high by 2 1/4 in. wide.  
No. 7900. Your net Cost..... **\$0.80**

#### TERMINAL STRIP MODEL

The primary and secondary leads are spaghetti covered, and unusually well soldered to generous size lugs. Strip is bakelite and properly lettered.  
No. 7950. Your Net Cost..... **\$1.01**

#### DUO-MAGNETIC CONE SPEAKER CHASSIS

No other magnetic speaker chassis is so strongly constructed! Note the heavily ribbed, sturdy "spider leg" white-lead casting! The entire frame work is one piece—a beautifully molded job! A Duo-Magnetic cone speaker unit is bolted to the rear mounting plate of the chassis, and the Burrex "ribbed" cloth cone is fastened between two heavy rings of cardboard—these rings are held in place by either screws and nuts, bolted to the frame of the chassis, or by being pressed up against a baffle mounting board. Although this speaker can be used as illustrated, it is strongly recommended that it be used in conjunction either with a baffle board or mounted within a box, a cabinet, or speaker compartment space in any console. The tone quality is comparable to any speaker selling for many times its trivial cost. It'll stand all the volume any radio set can "give it." Will work satisfactorily with a D.C. or an A.C. set—with 90 volts applied through it, or even as high as 500 volts! No blasting! No distortion! No rattling! You will be most impressed with its splendid performance! Overall dimensions: Diameter 9 in., width of mounting ring 1/2 in., depth (rear of unit to mounting baffle board plate) 6 1/4 in.; diameter of unit mounting plate 4 1/2 in.



No. 6850. COMPLETELY ASSEMBLED. Including DUO-MAGNETIC UNIT and cord. AS ILLUSTRATED. Your Special Net Cost..... **\$6.75**  
No. 6852. MOUNTED IN A CABINET OF EXTRAVAGANT BEAUTY. Your Net Cost..... **\$9.44**

# RADIO SPECIALTY CO.

**98C Park Place  
New York City**

BUY FROM RADIO'S OLDEST MAIL ORDER HOUSE

### A MULTI-METER

(Continued from Page 252)

calibrated for a "Readrite" 25-milliamperemeter. If the radio fan wishes to use a different type of meter, the resistance of the multiplier will have to be changed in proportion to the resistance of the milliammeter.

The resistance of the instrument used is about 300 ohms; on shunting the meter with a 0-to-300-ohm rheostat, and proper calibration for various settings of the rheostat, the milliammeter can be made to read up to half an ampere with fair accuracy. Higher readings can be obtained if the shunt resistor will carry the current without overheating.

#### Vacuum Tube Voltmeter

Test No. 5—In the first test the grid of the tube was not in the circuit; on closing switch 8a, and putting a potential, A.C. or D.C., on the "K" binding posts the reading of the meter will increase proportionally to the voltage impressed on the "K" terminals. K1-K1, K2-K2 and K3-K3 use different resistors and, by proper calibration with a standard meter, the milliammeter can be made to read accurately up to 400 volts A.C. In case you do not get a reading on the meter when A.C. is impressed on the "K" terminals, reverse the testing leads.

Test No. 6—This tester functions as a tube reviver. The procedure is the same as in the second test. A.C. is used to light the filament of the tube for the "baking" period. For the "flash" period a larger size lamp is used. The size of lamp required for the "flash" period for various radio tubes is given in Table I.

Test No. 7—When the tester is connected as outlined in No. 2, keeping switch 8c open, binding posts K4-K4 can be used to test for

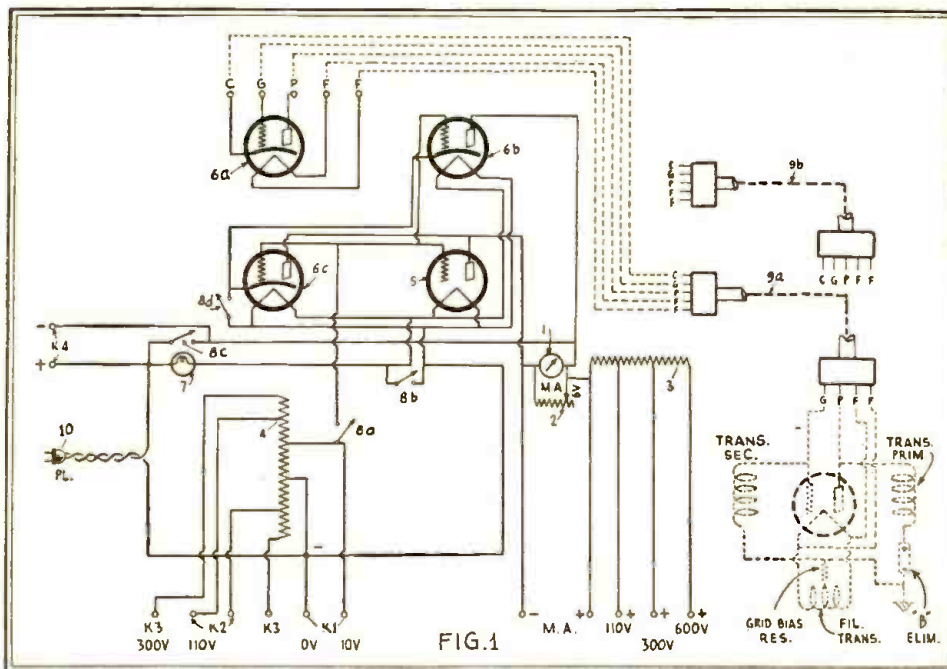

The complete connections of the Multi-Meter arranged for the tests described in the article. A standard tube is recommended for voltage tests. Units 6a, 6b and 6c are type UY sockets; 5 is a type UX socket (in the tester). Cables 9a and 9b must be low resistance.

an open circuit in the primaries or secondaries of transformers; also for the grid-bias resistors and grid-suppressors. These tests can be performed by using plugs 9a or 9b from the radio-set socket (of the particular transformer to be tested) and socket 6a. Binding posts "C," "P," "G," "F" and "F" are the testing points. The dotted lines and the dash-and-dotted lines illustrate how these points reach the parts to be tested through the flexible cables of the plugs.

This instrument has been used by the writer for several years as a tester for radio sets and also in his electrical laboratory. The radio fan building this instrument will find it a very useful unit in his laboratory or radio workshop.

#### Testing Screen-Grid Tubes

The schematic circuit (Fig. 2) illustrates how the screen-grid tube can be tested for plate

# FREE! COMPLETE COURSE in Radio and Television Through Courtesy of Organized Labor

A better understanding of the theory and mechanics of radio and television is essential to the fullest enjoyment of these two great inventions. To meet this imperative need ORGANIZED LABOR is supplying a complete course in Radio and Television FREE OF ALL COST to all who are interested. This great educational project is conducted in connection with Radio Station WCFL at Chicago—the only station built, owned and controlled by the wage earners.

This Free Correspondence Course includes: Theory of Radio and Television Transmission and Reception, Radio and Television Construction, How to Locate and Remedy Radio Troubles, How to Service Your Own Radio Set, Short-wave Adapters, and many other important subjects.

## Just the Thing for Beginners and for Boys

WCFL RADIO STUDY CLUB,  
625 South Wabash Avenue, Chicago.

Send me your Radio and Television Course. These lessons are to be sent to me FREE and without obligating me in any way.

Name .....

Street .....

Postoffice ..... State .....

Age ..... Occupation .....

This splendid correspondence course is distributed FREE through the WCFL RADIO STUDY CLUB. Membership in the Club, with first year's dues, is \$2.00, and includes an annual subscription to WCFL Radio Magazine—the only magazine fighting for the preservation of the Freedom of the Air, the most important subject now before the vast radio public. Special discounts also are available to members of

WCFL Radio Study Club  
625 South Wabash Ave., CHICAGO

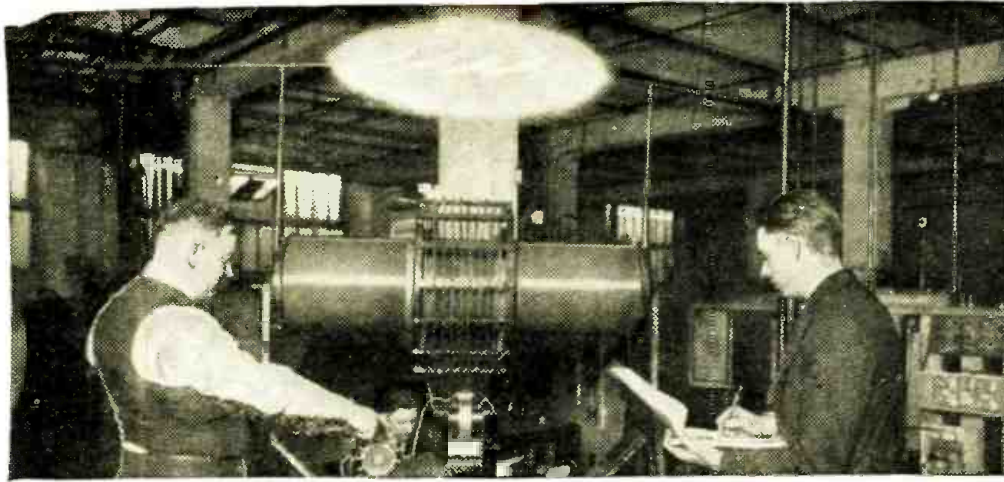

# 500,000 VOLTS

"Artificial lightning" being developed in COYNE school. Spark of 500,000 volts is shown jumping 30 inches. This gigantic Tesla coil is the same as that used by Steinmetz, absolutely harmless because of high frequency.

# LEARN ELECTRICITY Without Books or Lessons in 12 Weeks

## By Actual Work - In the GREAT SHOPS of COYNE



Anyone who can see and understand the English language can master Electricity in 90 days. I teach you with the most complete outlay of electrical apparatus ever assembled in any school—30-foot control board—2-story transmitting stations—skeleton houses, huge motors of all kinds—dynamometers—sub-stations—automobiles—switchboards. In one department we generate enough electricity to supply a small city!

### No Books - No Lessons - No Classes

ENTER ANYTIME. Experts teach you without books or classes. They guide you every step of the way with individual attention. You do the actual work on real full-size machinery in full operation. Take motors for instance. Instead of learning from books and charts—you actually build motors. You can't help but know all about them. Anyone can learn this fascinating way.

### No Experience Necessary

That's how my methods make men master electricity in 12 wonderful weeks. You don't need experience—Coyne training starts from the very beginning. You don't need advanced education—you learn by doing. Age is no handicap—Coyne students range from 16 to 40.

### TRIPLE YOUR EARNING POWER

I don't need to tell you about the opportunities in Electricity. They are too many and too amazing to mention. Ordinary jobs run from \$50—\$75—\$150 a week. And Coyne training leads to the biggest positions.

**COYNE Electrical School**  
H. C. LEWIS, President      Founded 1899  
500 S. Paulina St., Dept. 99-95, Chicago, Ill.

Many Coyne men are making up to \$600 a month. Demand for Coyne men often exceeds the supply. Our Employment Bureau secures dozens of positions weekly.

### EARN While You LEARN

We help many students to secure part-time jobs to earn a good part of living expenses while learning.

### Railroad Fare to Chicago Allowed

Right now I am including railroad fare to Chicago and complete courses in Radio, Aviation, and Automotive Electricity without extra charge.

### ALL DETAILS SENT FREE

This school is 30 years old—Coyne training is tested—proven beyond all doubt—endorsed by electrical industry. You can find out everything absolutely free. Simply mail the coupon and let me send you the big, free Coyne book of 150 photographs—facts—jobs—salaries—opportunities.

See what Coyne training can do for you in just 90 days! This does not obligate you. So act at once. Just mail coupon.



### Get This Free Book

H. C. LEWIS, PRESIDENT  
COYNE ELECTRICAL SCHOOL, Dept. 99-95  
500 S. Paulina Street, CHICAGO, ILL.

Dear Mr. Lewis:—Without obligation send me your big, free catalog and all details of Railroad Fare to Chicago, Free Employment Service, Radio, Aviation and Automotive Electrical Courses you are including, and how many "earn while learning."

Name .....

Address .....

City..... State.....

and screen-grid current values. To get the plate current reading all that is required is an extra wire from the cap of the tube to be rested to the clip which goes to the cap of the same tube when the tube is in the radio set.

To get the filament-to-screen-grid current emission, a slight change in the wiring of the meter is required; it also requires another 0 to 10 D.C. milliammeter.

To do this proceed as follows: Open up the wire running between the grids of the "plug" and testing socket as illustrated. Place one binding post at each end of the break, and connect the two binding posts with a piece of bus bar. When it is desired to make the test for screen-grid emission, remove the bus wire and insert the meter in its place. It will readily be seen that the meter is in the screen-grid circuit and therefore registers the current passing through it.

TABLE I

| Fil. Current of Radio Tube In Amps. | Wattage of Lamp Req'd. |   |
|-------------------------------------|------------------------|---|
|                                     | For Normal Current     | For "Flash" Period When Reactivating Tube |
| .06                                 | 10                     | 15  |
| .25                                 | 30                     | 75 to 100                                 |
| .5                                  | 60                     | 75 to 100                                 |
| 1.05                                | 120                    |   |
| 1.75                                | 200                    |   |

To find the size of lamp for any radio tube not listed above, use the following approximate formula:

$$LW = I(E - Et)$$

where, LW = size of lamp in watts required.

I = rated current of radio tube.

Et = rated voltage of radio tube.

E = line voltage, A.C. or D.C.

If LW happens to be an odd wattage, use a combination of 2 or 3 standard lamps in parallel to give the nearest watts required. This can be accomplished by putting in a multiple socket in the receptacle.

### LATEST THINGS IN RADIO

(Continued from page 264)

These condensers may be readily connected into the circuit by mounting them on pieces of bus-bar to fit into the tip-jacks of the unit.

The "Speakerelay," primarily, affords a

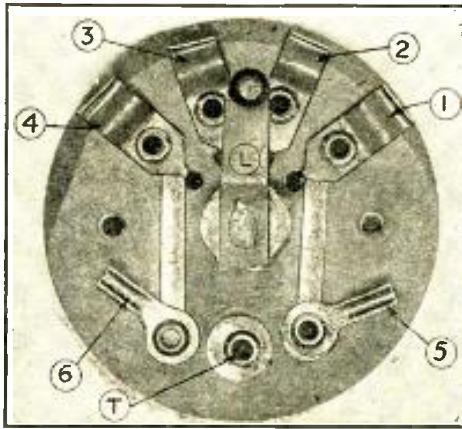

The switch-points as they appear in the "Speakerelay." 1, 2, 3 and 4 serve as tip-jacks and switch-points; 5 and 6, soldering lugs; T, hole for "tie-cord" of phone lead.

convenient means of determining the respective merits of two reproducers under substantially similar conditions; other uses will suggest themselves at once to the technician.

The mechanism is encased in polished black bakelite; and the instrument retails for \$2.00.

### R. C. A. TELEVISION WORK

(Continued from page 254)

tion. This could have been transmitted on one of the experimental phone wavelengths, but it was not considered necessary for the occasion. Picture transmission was on the allotted wavelength band between 143 and 150 meters.

Instead of confining the modulation to the customary audio limits of ten kilocycles, the modulation covered a band of about 100 kilocycles. This was nearly a 50-kilocycle swing each side of the assigned carrier frequency of experimental station W2XBS.

The antenna at the receiving end three miles away (experiments are being conducted daily to points as far as 20 miles away) accounted in part for the clear and satisfactory reception. The arrangement is attributed to Dr. Conrad and other engineers of the Westinghouse Electric and Manufacturing Company, who designed a "radio frequency transmission line" form of lead-in which has proved highly practical. The effect of the design is to reduce to a minimum pickup of "strays" of all types. In general, the idea consists of a stage of radio frequency amplification located at the antenna. The output of this R.F. amplifier is conducted to the receiver through a shielded cable and it is called the "transmission line." It has been found practical to use as high as ten broadcast wave and ten television wave amplifier units, each unit being connected to a different radio set, without objectionable interaction or loss of signal strength.

These "booster stages" may be used for operation on short wavelengths with even more success than on the regular broadcast wavelengths. In this particular instance, due

# S. GERNSBACK'S RADIO ENCYCLOPEDIA

## The First Radio Encyclopedia Ever Published

EDITED by SIDNEY GERNSBACK, Author of "Wireless Course in Twenty Lessons"—"One Thousand and One Formulas"—"Practical Electricity Course"—"The Radio Educator," etc.

S. GERNSBACK'S RADIO ENCYCLOPEDIA is the only standard work ever published in America attempting to classify alphabetically the countless words used in the highly specialized science of RADIO. The ENCYCLOPEDIA is written in plain English so that everybody can understand the definitions and descriptions.

No expense has been spared, covering over two years in compilation, to make it worthy a place in your library.

It is published in one volume—168 pages—size 9 x 12 inches, nearly an inch thick and nicely accommodates the beautiful illustrations and the large, easy-to-read type.

The work contains 1,930 definitions, 549 photographs, drawing and diagrams.

REMEMBER THIS IS A REAL ENCYCLOPEDIA—NOT A DICTIONARY—and very few of the things described and illustrated in this volume can be found in any dictionary, or any other encyclopedia.

The book contains as a supplement a classified cross index designed to bring together radio references under one heading having relations in common.

All circuits new and old are described by word and picture and every part and apparatus used in Radio is explained and made understandable by means of photographs and drawings.

The volume is printed upon fine paper—bound in full black Keratol, marbled paper fly leaves and end sheets, with the title stamped in gold.

Size 9"x12"



1930 Definitions

Regular Price \$2.00  
Our Special Price \$1.49

SEND NO MONEY  
Just Pay Postman

(Canada or Foreign send check or Money Order of \$1.75).

ISKOR PRESS, Inc.,  
286 Fifth Avenue,  
New York.

R-12

Send me one copy of Sidney Gernsback's First Radio Encyclopedia in one volume as advertised. I will pay postman \$1.49 plus postage on delivery.

Name .....

Address .....

Town and State .....

FULLY ILLUSTRATED

to the shielding effect of tall buildings (the electrical values of which are effective within the broadcast frequency range), the shorter waves were received best.

The R.F. stage units were powered by a current supply unit in a protected place on the roof, line current of 110 volts being wired to the unit and remote controlled.

The television console included a special amplifier for the "television frequency range," a scanning disk and a neon lamp. The amplifier was in two major sections, a radio-frequency amplifier and an intermediate frequency amplifier; an audio amplifier was not used, the output of the intermediate frequency amplifier connecting to the neon lamp and delivering power sufficient to operate the lamp at full glow.

The scanning disk is of 60-hole size. Square holes are used for the increased amount of light which will pass through them. The disk rotates at a speed of 1,200 R.P.M. For proper definition, or sharpness, 20 complete pictures per second were considered necessary. The picture appeared on a ground glass about five inches square. The disk does not require manual synchronizing as a method has been developed which makes automatic, the synchronous "tracking" of the transmitter and receiver disks. (Independent of electric line supply.)

**Newer Developments**

The laboratories associated with the Radio Corporation of America have developed an exceedingly compact and also portable "pick-up" unit. It has been termed a "television eye." It may be carried to any desired point of interest and the proceedings at that point transmitted to a companion receiving instrument. By a means not yet made public, it has been found possible to practically eliminate the scanning disk as it is generally known. The image produced may be seen with excellent clarity on a screen about 15x18 inches.

The receiving end of the latest television design is so compact that the entire equipment does not require a greater space than is required by the regular radio set of good construction.

It may be pointed out that the television unit cannot supplant but must supplement a good radio receiver. The completed "job" will probably include a short-wave pick-up and amplifying system designed for the television unit and another one designed for proper operation of a receiver operating on the broadcast frequency band.

Because of the unusually wide frequency band which must be simultaneously operated in with maximum efficiency at all points in that band, the so-called "short-wave adapter" will not prove suitable; pictures can be received, but the image is highly distorted due to lack of the higher frequencies filtered by the circuit as designed, and to uneven amplification which often exists. It is not evident to the ear but this distortion in the audio spectrum, may be "seen" when it is transposed to the visual spectrum.

About the future relations of Television and Broadcasting, Dr. Goldsmith has this to say: "It should be emphasized that ordinary broadcast receivers cannot receive television images, and vice versa, so that television and ordinary telephone broadcasting are separate and distinct services. Accordingly, owners or prospective purchasers of broadcast receivers need not be concerned that television will make their broadcast receivers obsolete. A complete service requires both a broadcast set for voice and music, and a separate television image receiver."

# The NEW H-F-L Mastertone Laboratory Made Receiver

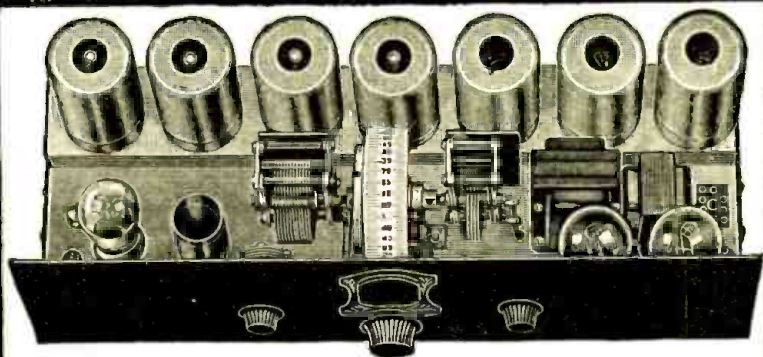

## Completely Built and Assembled by H-F-L Engineers - Shipped ready to Operate

All metal completely shielded chassis: 7" x 21" x 7 1/2". Fits nearly all consoles. 11 tubes operating at peak efficiency [5-224; 3-227; 2-245; 1-280.] Single dial positive one-spot tuning; Humless AC Operation; Uses 5 Screen-Grid tubes, 5 Tuned R. F. Circuits; High Power Screen-Grid detector, with 175 volts impressed on plate; Automatic line voltage control inbuilt holds voltage against fluctuating; 100-Volt DC Dynamic field supply incorporated; 3 stage Phonographic amplifier; Finest quality precision made parts.

**Amazing Power**

Startling realism! Unfailing accuracy! Its great power and sweet tone awe and thrill, setting new standards of performance achieved by H. F. L. engineers after two years of tireless research and tests under all conditions.

**Keenest Sensitivity**

Unlike any ever known! Gets distant stations clearly, sharply, distinctly with only wire screen or metal plate aerial built in cabinet.

**Highly Developed Circuit**

Intermediate employs 4 screen-grid tubes with 5 tuned filter circuits, easily adjustable to peak of tuned frequency. Positive 10 Kilocycle selectivity. Most highly engineered receiver ever built.

**The New Audio System**

Uniform amplification over entire musical scale. Operates with dynamic, magnetic or horn speakers without a bit of hum.

**The H-F-L Power Master**

Not an ordinary power pack, but a specially developed unit of the Mastertone, built separately to simplify installation. Has oversized transformer, full wave type 280 rectifier tube.

**Built by Hand—Yet Low in Price—**

Quality—not quantity—the H-F-L Mastertone standard. One demonstration will convince you that its the master receiver of all times. Fully guaranteed.

Write today for complete description and price.

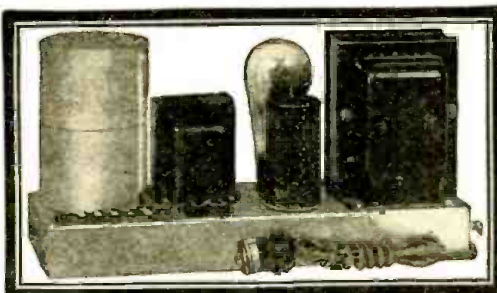

**HIGH FREQUENCY LABORATORIES**  
28 North Sheldon St. Dept. 71 Chicago, Ill.

### ATTENTION— RADIO SERVICE MEN

Leading manufacturers often consult us for the names of competent service men who are actively engaged in radio work.

We want every reader of RADIO-CRAFT who is engaged as a service man to read page 247 of this issue. You will find the few minutes reading this page well worth while.

### WHAT IS LOVE?

A New, Startling Revelation by a Paramount Authority

### LOVE AND MARRIAGE

By WINFIELD SCOTT HALL, M.D., Ph.D.

Unfolds the secrets of love and sex relationships fully and frankly. Gives intimate details of such vital subjects as Companionate Marriage and Birth Control. Why muddle along? Learn now about the sex and love instincts, how to select a mate, etc.

Decide today to have this new, precious knowledge, if you are a young man or young woman, if engaged or married, if a parent or teacher, or if a man or woman of 45.  
CLOTH, 366 PAGES

Only \$2.00  
We pay postage

JOHN C. WINSTON CO., 39 Winston Bldg., Philadelphia



# New! Adapter for the 245 SUPER POWER TUBE

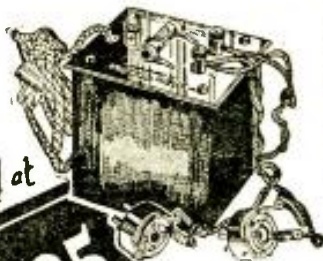

Special at

**\$7.95**

List Price  
~~\$15.~~

Bring your present set up-to-date using the New 245 Super Power Tube regardless of what you now have. No rewiring necessary. This adapter makes the job simple; any one can hook it up in a few minutes' time. Greater volume, finer clarity and an amazing ability to reproduce low notes are the features gained through the use of the new 245 tube and this adapter. Rewiring of your set is necessary if you do not use this adapter. You simply cannot do without it.

All Orders Must Be Accompanied  
By a Deposit of 20%

THE RADIO SET HOUSE OF BROOKLYN  
**BROOKLYN RADIO**  
Service Corp.

1072 Atlantic Avenue,  
Brooklyn, N. Y.

## INTERNATIONAL PROGRAMS

RADIO technicians will find the art entering a new cycle as rebroadcasting assumes greater proportions.

The Great Lakes Broadcasting Company, the Universal Broadcasting Company, and the Pacific-Western Broadcasting Federation have made arrangements with foreign countries to rebroadcast their transmissions.

The last-named concern is negotiating with the radio stations of 119 countries and provinces, and announces an almost complete program-interchange agreement between certain stations in Germany, Great Britain, Norway, Turkey, Italy, Spain and Japan. These relay transmissions will be handled on short waves not yet decided upon, with relatively high antenna power.

Engineers of the Federal Radio Commission, realizing these demands for channels, suggest an international division of time on a basis of so many days a week, or so many hours a day to each station, according to the Associated Press.

They point out this will afford a variety of foreign programs for listeners throughout the world. In this country, for example, the fan would be able to hear an orchestra in Berlin on Monday, a speech in London on Tuesday, melodies from Madrid or Buenos Aires on Wednesday, and the description of an international tennis match in France Thursday.

### INCREASING "WIRED WIRELESS"

EXPERIMENTS at Freeport, Ill., with the "wired wireless" system he has devised, according to Gen. George O. Squier, have shown that a five-watt transmitter output is sufficient to "saturate" 6,000 telephone lines, or "cable pairs," with modulated radio-frequency current sufficient for satisfactory use with special receivers. The radio-frequency carrier, of course, cannot be heard in ordinary telephone receivers.

The receiver designed for the purpose has three tubes; an A.C. screen-grid radio-frequency stage, a power detector, and an audio stage with sufficient output for a dynamic speaker. However, since only three carriers may be put at once on the telephone wires, the choice of programs with this apparatus is limited. Its operation is automatic; as it is pretuned, and only the pushing of a switch is necessary to start it and to tune in the optional programs.

In Cleveland a similar system will be in operation this fall over electric-light wires.

### BETTER TRANSMITTER SITES

THE importance of location in radio work is indicated by the announcement of the Westinghouse Company that the transmitters of KDKA and KYW, operated by that corporation, will be moved to more favorable sites in order to increase the effective area covered by them. Tests carried out by engineers indicate that KDKA's power will be most effective at Saxonburgh, the new site about twenty-five miles northeast of Pittsburgh, at an elevation of 1,300 feet.

In the case of KYW, (removed twenty-two miles from Chicago), its aerial will be separated from the transmitter building some distance, and placed over a "natural pond"; which presumably will serve in lieu of the elaborate counterpoise-ground of buried wires often used. Wooden masts, 110 feet high, will avoid the absorption of the wave, and consequent loss of field strength in certain directions, which metal towers cause.

# FLECHTHEIM SUPERIOR CONDENSERS NOT MERELY BETTER, BUT THE BEST!

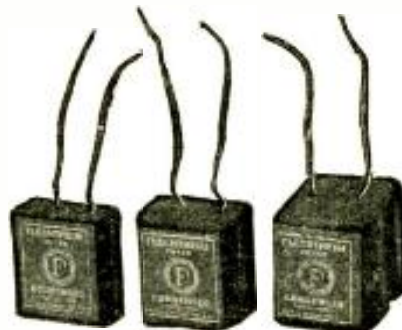

Uncased filter condensers, dipped in pitch, impervious to moisture and in every respect, a Superior Condenser. Rated at 450 V DC, equipped with wire leads and unexcelled for repair, replacement and constructional radio work. Available in .1, .25, .5, 1, 2 and 4 mfd capacity at very attractive prices.



Our highly developed "A" filter condensers are the best you can obtain, for "A" eliminators or dynamic speaker fields. In 1000 mfd at 12 volts; 2000 mfd at 18 volts and 4000 mfd at 12 volts.

The Famous Flechtheim Midget Condensers are well known among radio men who appreciate accurate capacity, minimum rf impedance and a high value of resistance to DC. Electrostatically shielded.

The greatest development in condensers, today — type HV, rated at 800 V DC, (550 rms RAC max.), having the finest electrical characteristics, and the smallest physical dimensions. For the portable, receiver, transmitter or power pack (especially designed for the 245).



### FLECHTHEIM SUPERIOR VOLTMETERS



If you haven't one of our 0-300 DC, 0-500 DC or 0-600 AC & DC meters, get one today. Most essential to the efficient service man.

Send For Latest Catalog  
**A. M. FLECHTHEIM  
& Co., Inc.**

136 Liberty St., New York, N. Y.

## PATENTS TRADE-MARKS

DON'T LOSE YOUR RIGHTS  
TO PATENT PROTECTION

Before disclosing your invention to anyone send for blank form "EVIDENCE OF CONCEPTION" to be signed and witnessed.

LANCASTER & ALLWINE  
(Registered Patent Attorneys)  
475 OURAY BLDG., WASHINGTON, D. C.  
Originators of forms "Evidence of Conception"

## SONG WRITERS!

Substantial Advance Royalties are paid on work found acceptable for publication. Anyone wishing to write either the words or music for songs may submit work for free examination and advice. Fast experience unnecessary. New demand created by "Talking Pictures", fully described in our free book. Write for it Today—Newcomer Associates  
751 Earle Building, New York, N. Y.



**START to PLAY  
Very First Day!**

Pleasant,  
Easy  
Lessons  
Show You  
How!



A lifetime of rich, wholesome fun. 5 days' free trial in your own home. A year to pay.

THE whole world seems different when you learn to play and now you can play the most spectacular of all instruments—the Deagan Xylorimba. No long waiting. No finger or lip exercise. No tiresome practice. Start to play very first day even if you can't read a note of music right now. Soon you'll be the "hit" of every party. Maybe, like the Musical Hallmans (Reading, Pa.) you'll make \$65 a week spare time.

**Our Big Free Book** tells all about the free trial offer, the easy lessons, the wonderful payment plan. No cost or obligation—send in coupon today.

J. C. Deagan, Inc., Dept. 1938,  
1770 Berteau Ave., Chicago.

Send me, without obligation, full details of Free Trial offer and easy-payment plan of the Deagan Xylorimba.

Name .....

Address .....

**CHEMISTRY**

IF you are interested in chemistry, you will be pleased to hear that a magazine written in plain English, containing a vast amount of information for the beginner and the more advanced student in chemistry is being published now.

**Chemical Experimenter**

is a Monthly Magazine chock-full of interesting Departments, edited by men who know how to state worth-while facts.

There are Departments about: "Chemistry in the Home" — "History of Chemistry" — "Experiments in Chemistry" — "Biographies of Celebrated Chemists" — "Chemistry for the Beginner" — etc., etc.

Send the coupon below and you will receive all information about this Magazine.

CHEMICAL INSTITUTE OF NEW YORK,  
16 East 30th Street, New York, RC-12  
Gentlemen:

Please send me free of charge all information about

**CHEMICAL EXPERIMENTER**

Name .....

Address .....

Town .....

**Choice of 1200  
Newest  
RADIO  
VALUES**

SEND for our 1930 catalog. Filled with amazing values in screen grid radios, push pull audio, consoles, kits, parts. All standard makes and guaranteed merchandise. **FREE**

**WESTERN RADIO MFG. CO.**  
124 W. LAKE ST. CHICAGO, ILL.

When writing to advertisers, please mention RADIO-CRAFT.

**PRESCRIPTIONS OF A RADIO DOCTOR**

(Continued from Page 248)

broadcast band) and connect it across the antenna and ground. (It may be convenient to try this coil in series with the resistor.—Editor.) If the coil is provided with a primary, this should be ignored and the secondary alone used; the primary winding may be removed if desired. Coils obtained from an old three-dial tuned-radio-frequency set were used and, since they were of the basket-wound pattern, took up little space.

**Hum in Stromberg-Carlson**

In one instance a Stromberg-Carlson set No. 635 developed a hum after a period of about six months' steady use. There are two "hum

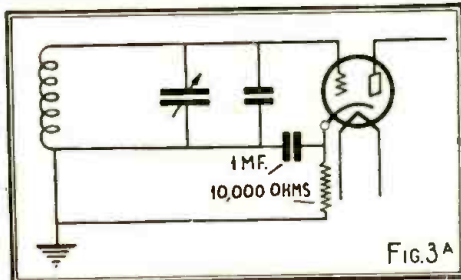

In certain of the Stromberg-Carlson models, as explained in these columns, plate rectification is employed. This alters the detector circuit only to the extent shown.

balancers" at the rear of the chassis, and these when adjusted failed to reduce the hum. Indications were that the filament supply was grounded; undoubtedly the audio filament supply, since the dial light went out when the "hum balancer" was turned as far as it would go in one direction and the "hum balancer" of last audio tube when turned did not effect a balance.

This conclusion proved correct for, when the dial light bracket was examined, it was found to be bent forward and one side of the lamp socket was making contact with the dial and thereby grounding the '71A filament

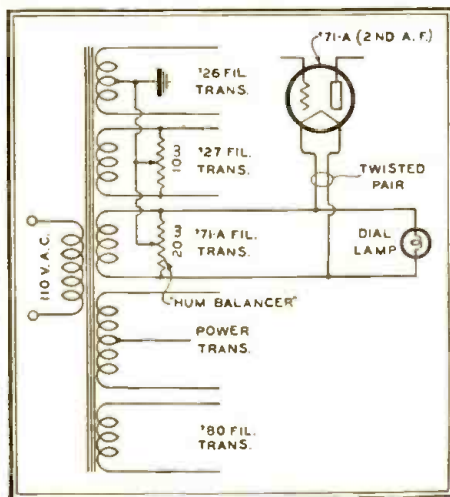

Fig. 3B

The power-transformer windings of the Stromberg-Carlson "635" and "636," showing how a ground in the filament circuit introduces hum.

circuit. The portion of the set in question is shown in Fig. 3B. This trouble has been experienced also in the 636 type Stromberg-Carlson receiver. (The change in the detector circuit of these models with plate rectification is shown in Fig. 3A.)

**Open!**  
**THOUSANDS OF  
RADIO  
JOBS like these!**



Radio repair mechanics earn from \$1800 to \$4000 a year.

Radio Operators \$90 to \$200 a month (board free).

Pick the job you want—see what only 9 months training will do!

**MAKE** big money in Radio. It's a big pay business. Salaries from \$2,000 to \$25,000 a year are common. Broadcasting stations and manufacturers are now eagerly seeking trained men... Thousands of ships require experienced operators.

**Easy to Learn at Home With This Magnificent Laboratory Outfit**

The Radio Corporation of America sponsors this marvelous, simplified home training course... Prepare for success in every phase of Radio... by actual experience with apparatus given with this course... learn how to solve every Radio problem.

**Only Course Backed by Radio Corporation of America**

This gigantic organization sets the standards for the entire industry... and sponsors every lesson in the course. That's why graduates are posted in newest developments in Radio. That's why they are always in big demand.

**Money Back if Not Satisfied**

As a student you will receive an agreement signed by the president of this school assuring you of complete satisfaction upon completion of your training—or your money refunded.

**READ THIS FREE BOOK**

Free... everything you want to know about Radio... 50 fascinating pages... packed with pictures and descriptions showing brilliant opportunities in this fast-growing profession. See for yourself why R.I.A. training has placed thousands of men in well paid positions—usually from 3 to 10 days after graduation. Mail this coupon now and receive your FREE BOOK.



**RADIO INSTITUTE OF AMERICA**  
Dept. RC-12, 326 Broadway  
New York, N. Y.

Gentlemen: Please send me your FREE 50-page book which illustrates the brilliant opportunities in Radio and describes your laboratory-method of instruction.

Name.....

Address.....

**44<sup>TH</sup> ST.  
HOTEL**  
Just East of B'way

*One of New York's  
New Hotels at Right Prices*

A high class hotel in the very center  
of Times Square and within walking  
distance of all Shops, Theatres, etc.  
**300 Rooms—300 Baths**  
**\$2.50 & \$3.00 per Day**  
A Restaurant of Unusual Excellence  
*Special Weekly Rates*

# 10 Tools in One

A SMALL but handy article which serves for every possible need of the all-round mechanic. Invaluable in any emergency.

An excellent combination of utilities for the household—every necessity featured:

- |                   |                   |
|-------------------|-------------------|
| HAMMER — KNIFE-   | CAN-OPENER —      |
| SHARPENER — NAIL- | WEIGH-SCALE—RULER |
| PULLER — BOTTLE-  | —TABLE OF WEIGHTS |
| OPENER — SCREW    | AND MEASURES.     |
| DRIVER—CORK-SCREW |                   |

Just glance at the illustration and you will see how really useful this article is. The "Ten in One Tool" is 10 inches high and finely nickel-plated.

The new tool is not only handy in the household, but every TOURIST, AUTO-IST, CAMPER, PICKNICKER, BOY-SCOUT, FISHERMAN, CANOEIST, etc., should carry in his bag one of these indispensable combination tools. No SHOP, OFFICE, STORE, GARAGE, FARM, BOAT, should be without one. PRICE \$1.00 POSTAGE PAID.

Be the first one to own the "Ten Tools in One" in your own town.

Send your order today, pin a dollar bill to coupon below and the shipment will go forward to you the same day as received.

**GRENPARK TOOL CO.**  
245 Greenwich St.,  
New York

Grenpark Tool Company, R-12  
245 Greenwich Street,  
New York, N. Y.

Enclosed find \$1.00 for which please send me prepaid your "Ten Tools in One."

Name .....

Address .....

Town..... State.....

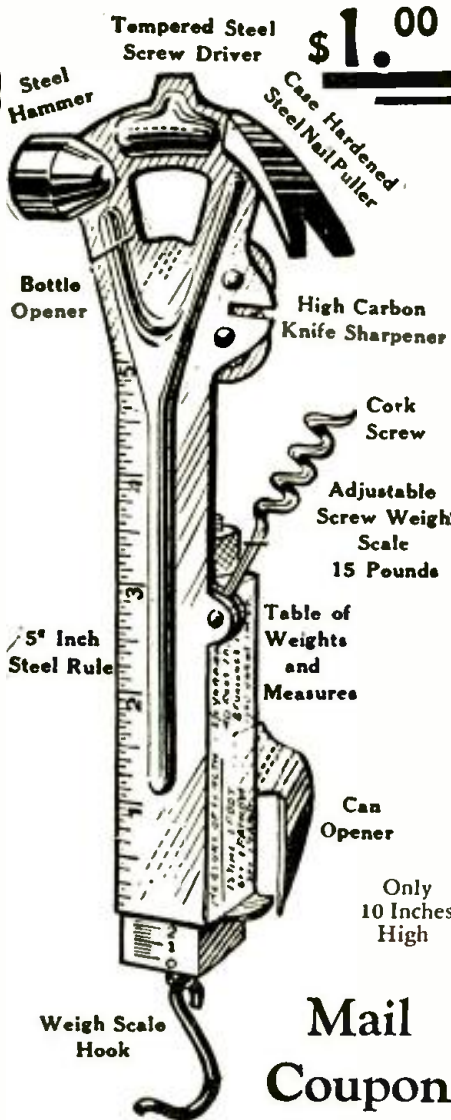

**\$1.00**

**Mail  
Coupon**

**Send for Yours  
TO DAY**

## Letters From Radio Service Men

(Continued from Page 246)

### The Manufacturer's Part

The real answer to the question must come from the R.M.A. Manufacturers must, in the near future, seriously consider the independent service station. Few of the stores selling radios pay enough attention to their service department; thus forcing the customer to call in an independent service man when they want satisfactory service. *It's up to the manufacturer* to see that these men are supplied with all the information necessary to intelligently repair the sets that have passed the usual guarantee, if the manufacturers want to keep in the good graces of the public.

Human nature is about the same the world over. When an independent service man writes to a manufacturer for a circuit diagram and continuity chart, and for answer is told it is not the company's policy to furnish any except to their authorized dealers, that company loses money; because a lot of high-priced advertising is going to be nullified in the circle of possible buyers that service man deals with.

It's taken me quite a few years to make my collection of circuit diagrams, continuity charts, and other information of past and present sets, and in acquiring it I also have been snubbed by certain manufacturers, when I would repair their sets regardless of whether they sent me the information I asked for or not.

### Standard Service Diagrams

Let the R.M.A. take this up. Have the individual companies furnish a light cardboard sheet for each receiver; one side a complete circuit diagram, the other side giving a continuity chart and what other information is necessary for testing the tuner and power pack. Let one standard set analyzer be the medium for making all tests and checks; eventually all service men will revamp their old ones or buy a new one. Have these charts at one central distributing point and advertise that any service man writing under his own letterhead or that of the store he works for, can have them either free or for the cost of printing. Do this, and each manufacturer will save many more dollars than it costs him; besides having a bunch of service men (and they are many) boosting instead of knocking. Not only that, but the manufacturer will have a check on these men who are such a "menace" to their slipshod dealers' service departments.

Most of the independents are giving better service because they have dollars invested, where the average dealer has pennies. Out of the limbo of experimentation and guesswork, we (my son and I) are building up a profitable business, and are commencing to enjoy a reputation for good honest service; which, I believe, is what every service station should strive for. The money end will take care of itself.

How do I test a radio?

Part of my "system" I've explained, but I have also told you how we could have a real system that would increase the good will of the public toward the manufacturer, and save money for the customer, for in the end it's always the customer who pays.

D. F. MORRISON & SON,  
Elmira, N. Y.  
By "The Old Man" himself.



## VACUUM TUBES FOR RADIO RECEPTION

(Continued from Page 256)

a filament drawing half an ampere, as in the '12 type. It has a low amplification-factor and a very low output impedance, and for this reason it is useful only in the last stage of the set. The plate current of this tube is too high for the average loud-speaker winding and therefore some type of output-coupling transformer or impedance must be used in order to protect the winding from breakdown. This output-coupling device may be used to balance the impedance values of the tube and speaker, if desired, in the manner described some time ago.

As in the case of the '12A type, the '71A filament may be operated from either a battery or a step-down transformer. The undistorted output of the '71A tube is much higher than that of the two tubes described above and, with most receivers, except where extreme volume is desired, sufficient volume can be obtained without overloading this tube. The output value can be increased almost three times by using the "push-pull" system, with two of these tubes.

Fig. 3 shows the wiring of a push-pull amplifier. It will be noticed that two resistors are connected between the filament and the plate wiring; they are used to obtain "C" bias and filament balance. R1 is the filament-balance resistor; it has a value of ten to thirty ohms, and the adjustable center tap permits the plate and grid circuits to be connected to any point on its length. In this way, these two circuits may be connected to the effective center point of the filament circuit, with the result that the A.C. hum is reduced to a minimum.

The other resistor R2 gives the "C" bias. (We have explained the operation of these resistors in the previous issue of RADIO-CRAFT, and given the method of figuring the correct value; so that no further explanation should be necessary. A 2150-ohm resistor gives a 43-volt drop at 20 milliamperes plate current.) The condenser shunting this resistor is a very necessary piece of apparatus; for otherwise the signal currents in the plate and grid circuits must pass through the resistor, and this would result in a reduction of signal strength or a loss of quality. The only other parts in the amplifier are the transformers, which are of the usual type of push-pull design. No comment is necessary about these instruments; the only requirement is that they be of the best quality, in order to maintain high fidelity in the output.

Since its development, the '71A tube was used in almost all the popular commercial sets until recently; but the appearance of the new '45 tube with its higher output value has threatened its supremacy to some extent. The following are the figures for the '71A:

Filament voltage, 5 volts; current 0.25-ampere;

Plate voltage, 135 to 180; current 16 milliamperes at 135 volts, 20 ma. at 180;

Grid bias, 27 volts at 135 plate volts, 40½ volts at 180. (When A.C. is used for the filament supply, it is necessary to increase this bias value by one half the filament voltage—in this case, 2½ volts.);

Plate resistance, 2,200 ohms at 135 volts, 2000 ohms at 180;

Amplification-factor, 3;

Undistorted output, 330 milliwatts at 135 volts, 700 milliwatts at 180.

Fig. 4 shows the characteristics of the '71A

tube plotted against plate current in milliamperes. The value of "mu" and the curves for the plate resistance and mutual conductance are plainly shown. The use of a graph of this type gives a very clear and concise impression of the characteristics of the tube under different conditions.

The first three tubes in the power-tube series just described, have very definitely limited output values, beyond which considerable distortion occurs. Where more than a moderate signal strength is required, as in the case where a large room, an auditorium, or an outdoor area, is to be filled with either radio or phonograph music, some means has to be devised to get a larger value of undistorted output.

It is comparatively easy to obtain a grid swing sufficiently large to produce tremendous volume, especially with the new screen-grid tubes. It is necessary only to obtain some device which will successfully handle this wide grid-voltage swing, and couple it to the speaker, in order to obtain the desired results.

### The Largest Power Tubes

The '10, '50 and '45 tubes are a series successively designed with this point in view. The last-named tube is the latest and, because of the comparatively low plate voltage required as well as the high output, it is becoming very popular in all types of sets.

The filaments of these three tubes are heavy, and require high currents to bring them to the correct temperature. For this reason, alternating current is invariably used as the source of supply in commercial practice. The filament of the first of these tubes, the '10, requires 7.5 volts at a current of 1¼ amperes. This tube has a higher amplification factor than the other two and, for this reason, it is more suitable in audio channels where the grid swing is not very high. Its undistorted output also is lower than that of the others; and these characteristics place a limit on the use of the tube. Fig. 5 gives the characteristics of the tube plotted against plate voltage up to 300.

Filament voltage 7.5; current 1.25 amperes (A.C. from a step-down transformer);

Plate voltage, 250 to 450;

Plate current, 12 milliamperes at 250 volts, 16 at 350, and 20 from 400 to 450;

Grid bias, 18 volts at 250 volts, 27 at 350 and 35 at 425 volts;

Plate resistance, 5600 ohms at 250 volts, 5000 at 425;

Amplification-factor, 8;

Undistorted output, 340 milliwatts at 250 volts, 925 at 350, 1540 at 425;

The largest tube of the series is the '50, which was designed to supply a very large amount of current to the speaker, and will handle a very wide grid swing without overloading. Like the '10 tube, this valve requires 1.25 amperes for the filament at 7.5 volts. In this case also, alternating current is invariably used as the source of supply. This tube will give more than three times the undistorted output of the '10; it has a lower amplification factor, however, and must be given a wider grid swing than the smaller tube, to obtain the same volume. The advantage is in its greater power-handling ability.

Like the '71A tube, the '50 has a very low A.C. plate resistance, and it is advisable to use a coupling device of the type which permits matching the plate and speaker impedances. Because of the high voltages and current needed to operate this tube, special precautions must be observed in using it. If a short-circuit should occur or one of the filter condensers break down, the result might be a fire. It is therefore necessary to use the high-

# Here's the Answer

to every question about the principles, methods, or apparatus of radio transmitting and receiving. A complete course in radio operation in a Single Volume

## THE RADIO MANUAL

A New Edition

Complete new chapters on aircraft radio equipment; Practical Television and Radiomovies with instructions for building a complete outfit; radio interference; 100% modulation; latest equipment of the Western Electric Co.; the Marconi Auto-Alarm System; and many other developments of the past year. All this information is added to the new edition and, besides, the entire book has been brought right up to date with much new material. THE RADIO MANUAL continues to be the one complete and up-to-the-minute handbook covering the entire radio field.



A Handbook for Students Amateurs Operators Inspectors

Twenty big chapters cover: Elementary Electricity and Magnetism; Motors and Generators; Storage Batteries and Charging Circuits; The Vacuum Tube; Circuits Employed in Vacuum Tube Transmitters; Modulating Systems and 100% Modulation; Wave-meters; Piezo-electric Oscillators; Wave Traps; Marine Vacuum Tube Transmitters; Radio Broadcasting Equipment; Arc Transmitters; Spark Transmitters; Commercial Radio Receivers; Marconi Auto-Alarm; Radio Beacons and Direction Finders; Aircraft Radio Equipment; Practical Television and Radiomovies; Eliminating Radio Interference; Radio Laws and Regulations; Handling and Abstracting Traffic. An immense amount of information never before available including detailed descriptions of standard equipment is presented.

### Prepared by Official Examining Officer

The author, G. E. STERLING, is Radio Inspector and Examining Officer, Radio Division, U. S. Dept. of Commerce. The book has been edited in detail by ROBERT S. KRUSE, for five years Technical Editor of QST, the Magazine of the American Radio Relay League. Many other experts assisted them.

### Free Examination

The new edition of "The Radio Manual" has just been published. Nearly 900 pages. 369 illustrations. Bound in Flexible Fabrikoid. The coupon brings the volume for free examination. If you do not agree that it is the best Radio book you have seen, return it and owe nothing. If you keep it, send the price of \$6.00 within ten days.

### Order On This Coupon

D. Van Nostrand Co., Inc.,  
250 Fourth Ave., New York  
Send me the Revised Edition of THE RADIO MANUAL for examination. Within ten days after receipt I will either return the volume or send you \$6.00, the price in full.  
(Radio Craft 12-29)

Name .....

St. and No. ....

City and State .....

**Orders - Inquiries**

60 pages  
Send for FREE Copy  
Can be Secured by MAIL

**POLK'S REFERENCE BOOK and Mailing List Catalog**

Gives counts and prices on over 8,000 different lines of business. No matter what your business, in this book you will find the number of your prospective customers listed. Valuable information showing how to use the mails to secure orders and inquiries for your products or services is given.

Write for FREE Copy  
**R. L. POLK & CO., Detroit, Mich.**  
Largest City Directory Publishers in the World. Branches in Principal Cities. Mailing List Compilers—Business Statistics Producers of Direct Mail Advertising

At Last!—a book containing all the rules of commercial and government radio traffic—and operating regulations.

The Only Book of Its Kind.

**Radio Traffic Manual and Operating Regulations**

By R. L. Duncan and C. E. Drew

RADIO INSTITUTES OF AMERICA

At last here is a book for students, amateurs, and radio operators who contemplate entering the commercial field. With the help of this little book—the only complete one of its kind—you may learn quickly and easily all the government and commercial traffic rules and operating regulations.

Duncan and Drew, the two well-known authors of "Radio Telegraphy and Telephony," have set forth clearly and accurately in 181 pages all the information on the subject that you will want. Every thing from Morse Code and Conventional Signals to the Issuance of Radio Operators' Licenses is included in detail. An excellent index in the back of the book makes every topic easy to locate.

\$2.00

**On Approval Coupon**  
John Wiley and Sons, Inc., 440 Fourth Avenue, New York.  
Gentlemen: Kindly send me on approval Duncan and Drew's "Radio Traffic Manual." At the expiration of ten days, I agree to remit \$2.00 or return the book postpaid.

Name .....

Address .....

Reference ..... R.C. 12-29

**TO NEW READERS**

A few copies of the July, August, September, October and November issues of

**RADIO-CRAFT**

can still be had at the regular price of 25c each. Send stamps, cash or money order to:

**RADIO-CRAFT**

98 Park Place New York, N. Y.

est grade of condensers in all the high-voltage circuits of both the amplifier and the plate-supply unit; and it is advisable also to place fuses in both of the primary leads of the power transformer, to prevent trouble. These fuses should be rated at about 5 amperes, so that they will melt very quickly. The wiring of the amplifier should be done with extreme care and well-insulated wire must be used.

Filament voltage 7.5; current 1.25 amperes;  
Plate voltage, 250 to 450;

Plate current, 28 milliamperes at 250 volts, 35 ma. at 300, 45 at 350, and 55 from 400 to 450;

Grid bias, 45 volts at 250 plate volts, 54 at 300, 63 at 350, 70 at 400 and 84 at 450;

Plate resistance, 2100 ohms at 250 volts, 2000 at 300, 1900 at 350 and 1800 from 400 to 450.

Amplification-factor, 3.8;

Undistorted output, 900 milliwatts at 250 volts, 1500 at 300, 2350 at 350, 3250 at 400 and 4650 at 450. In push-pull, two '50 tubes will give over thirteen watts—sufficient to operate a battery of dynamic speakers for a theatre or public address system.

**The Type '45 Tube**

The latest of the power-tube series is the new '45 type, now coming rapidly into favor. It will give a power output between those of the '71A and the '50, with comparatively low plate voltages. It is designed primarily for operation in domestic A.C. sets and, for this service, it incorporates a very sturdy filament which, however, is made for a 2.5-volt supply.

The tube is designed to operate at plate voltages from 180 to 250 volts maximum. In electrical characteristics it is similar to the '71A in that the amplification factor is 3.5, the plate resistance is 1900 ohms, and the mutual conductance is 1850 at a plate voltage of 250. The '45 tube is not interchangeable with the '71A, however, because of the lower voltage required for the filament. When inserted in the socket designed for the '71A, a '45 will burn out, if the filament winding of the power transformer does not go first. The '45 filament requires 2.5 amperes to bring it to the correct temperature; and a fluctuation of 5%, above or below the rated voltage of 2.5, is permissible with no ill effects. The last-mentioned characteristic tends to reduce the effect of line-voltage changes which have been so disastrous to tubes in some locations.

One precaution must be observed in operating the '45 tube; the grid bias must never be removed. If the "C" battery should become short-circuited, the plate current would increase sufficiently to overheat the elements and would probably cause permanent injury. It is desirable to obtain the grid bias from a resistor in the plate-return lead; it will be found that this compensates almost completely for changes in plate potential. By this we mean that, if the plate voltage either increases or decreases, the grid bias also increases or decreases, thus maintaining the balance. This is because the change in voltage causes a proportionate one in the plate current. When the plate current changes, the voltage drop through the resistor does so too (according to Ohm's law); with the result that the "C" bias is altered proportionately.

A very handy chart of plate-current values for different tube charts has come to our attention, recently, in the technical bulletin of one of the large tube manufacturers; this is reproduced as Fig. 1. It is very handy data for the service man to keep beside his set tester.

**Can You Outguess O. Henry?**

Can you look ahead in an O. Henry story and see the unexpected denouement, the strange twists of plot, the breath-taking finish? Try it? If you succeed you can out-think the best minds in the world, for the genius of O. Henry sets the wits of the brilliant people of all lands working at top speed and still he amazed them all! He is the supreme master of the "trick" ending, luring you into sudden laughter while a lump still lingers in your throat—making you gasp by a sudden livid flash of horror in the midst of a smoothly flowing tale.

**Stories of Wit and Pathos**

Gentle is O. Henry, but manly strength glows in every virile sentence; tender with the suffering; ever kind to the under dog; chuckling with the light-hearted—drawing always from his unshined depths of understanding the sparkling crystal of sincerity. A great writer, yet the most entertaining and thrilling companion. Reading his stories is like

**The Master Story Teller**



**Why DO YOU READ?**

listening to a more brilliant story-teller than you ever knew. His works immeasurably enrich the limited library, and grace the shelves of the most crowded.

53 BEST STORIES

Less than 4 cents each **\$1.97**

You are now offered for the first time 53 engrossing living, selected stories, handsomely and durably bound in leatherette, stamped with gold. 500 pages, all for the price of only one ordinary short novel.

For entertainment? For escape from daily drabness? For romance, adventure, thrills? To sharpen your wits or exercise your emotions? Whatever your reason, O. Henry's scores on every point.

**CUT PRICE COUPON**

Grenpark Company, Dept. R.C.-12  
245 Greenwich St.,  
New York, N. Y.

Please send me O. Henry's Best Stories at the cut price of \$1.97. I enclose stamps, check or M. O. for the amount. (Check which).

Name .....

Address .....

City and State .....

**PATENTS**

**Protect Your Ideas**

Write for Instructions, free on request - - or send drawing or model for preliminary examination of Patent Office records

Promptness Assured with Best Results

**Carl Miller**

PATENT ATTORNEY

FORMER MEMBER EXAMINING CORPS, U. S. PATENT OFFICE

265 MCGILL Building WASHINGTON, D. C.

# SKINDERVIKEN Transmitter Units

95c



Two for \$1.75

Have hundreds of uses. Every amateur should have two or three of these amplifiers in his laboratory.

## A FEW USES FOR THESE UNITS

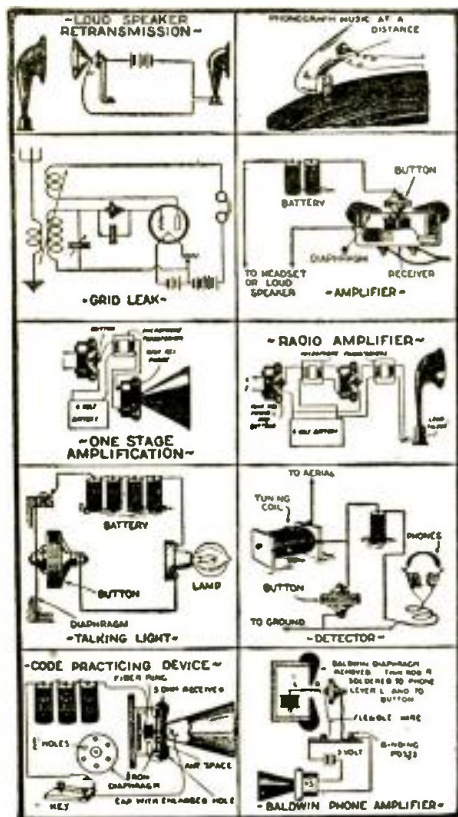

12 PAGE INSTRUCTION BOOKLET containing suggestions and diagrams for innumerable uses, furnished with each unit.

**WE PAY \$5.00 IN CASH**

for every new use developed for this unit and accepted and published by us.

### P. G. MICROPHONE TRANSFORMER



A Modulation Transformer specially designed for use with the Skinderviken Transmitter Unit. Has many other uses. Primary resistance, 1/2-ohm; secondary, 55 ohms.

\$2

**FOR SALE AT LEADING DEALERS**  
Or Order Direct. Using Coupon Below

## SEND NO MONEY

When the postman delivers your order you pay him for whatever you have ordered, plus a few cents postage.

PRESS GUILD, Inc. R-12-29  
16-18-R—EAST 30TH ST., NEW YORK, N. Y.  
Please mail me at once as many of the following items as I have indicated.  
... Skinderviken Transmitter Units at 95c. for 1; \$1.75 for 2; \$2.50 for 3; \$3.20 for 4.  
... P. G. Microphone Transformers at \$2.  
When delivered I will pay the postman the cost of the items specified plus postage.

Name .....  
Address .....  
City ..... State .....

## A RADIO WORK BENCH

(Continued from Page 258)

The table may be stiffened as indicated in Fig. 3, if desired, by the use of a "spreader" consisting of two 10 1/2" lengths of 2x4 at the bottom and a longitudinal brace of the same stock, 38 1/2" long.

The table is then completed by fastening on, for its top, the two widest boards (4 1/2" x 10") with the 2 1/2" flat-head screws, counter-sunk in and mounting the binding posts. The duplex A.C. outlet may, perhaps, be more conveniently first attached to the frame.

### The Test Board

To assemble the back of the bench is very simple. The ceiling material used is grooved on one edge of each piece, and tongued on the other to fit the groove of the next. Start six inches from the bottom of the cleats; and nail the first piece of ceiling to each cleat, with finishing nails through both grooved and tongued sides. Each succeeding piece need be nailed only through the tongued side; and the tongue is trimmed evenly off the topmost piece. The test-board foundation may now be placed flush against the back of the work-table, to which it is firmly bolted.

The meters are taken from their mountings (if any) and remounted in the bakelite panels; wires are run to the phone-tip jacks, which are mounted in the panels and, of course, designated on the outside of the panel above each. The panels then are fastened to the test-board, using 1-inch sleeves, or spools over screws, between the board and each panel. The final arrangement is indicated in Fig. 3.

## RADIO-CRAFT KINKS

(Continued from Page 259)

cord and then pulled through the tube will make excellent contact.

(4) Pass the lamp cord through the wide opening of the handle and pull through the small hole (Fig. 1B).

(5) Push the brass tube into the handle tightly.

(6) Leave the brass caps on the battery carbons. Rub the other end back and forth on a file to shape in any manner desired.

Take flame-spreader out of gas tip (Fig. 1C).

(7) Solder one clip to lamp cord and the other two clips to another piece of lamp cord about 2 ft. long.

Operation: Connect the soldering-iron clip to one terminal of battery or transformer, connect one clip on other wire to other terminal. Insert the carbon rod into the gas tip through the large end of the tip and screw on to brass tube.

Connect the other clip to object to be soldered; or, if object is small, connect the clip to piece of solder. Hold solder close to object to be soldered and touch with solder.

### ERRATA

In the October issue of RADIO-CRAFT, page 158, the ground lead on the "B" side of the R.F. transformer primary in the plate circuit of V2 should be removed. Instead, a fixed condenser connects from the socket leads of the screen-grids of tubes V1 and V2 to ground.

In the November issue, page 199, a fixed condenser should be inserted as a by-pass in the ground lead which is shown connected around resistor R2.



## AUDIO TRANSFORMERS Worthy of the HAMMARLUND Name Plate

DESIGNED primarily for the new "Hi-Q-30" Custom-Built Receiver, Hammarlund Transformers are a revelation in amplifying power and tone fidelity over the entire audible frequency range.

The large cross-section core of specially treated laminations permits high primary currents without saturation. Completely shielded. Pigtail terminal leads for sub-panel connection.

Four types:—First stage, Push-Pull Input, Push-Pull Output for magnetic speakers, Push-Pull Output for dynamic speakers.

Hear them! Try them! They will greatly improve the output from any circuit.

Write Dept. RC12 for Details

**HAMMARLUND MFG. CO.**

424-438 W. 33rd St., New York



Choice of 1200  
Newest  
**RADIO VALUES**

SEND for our 1930 catalog. Filled with amazing values in screen grid radios, push pull audio, consoles, kits, parts. All standard makes and guaranteed merchandise. **FREE**

**WESTERN RADIO MFG. CO.**  
174 W. LAKE ST. CHICAGO ILL.

### ALUMINUM BOX SHIELDS

Beautiful silver dip finish, 5/8"x9"x6"—\$1.75. We make any size to order in 24 hours.

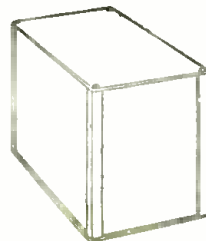

- Pickle Bottle Antenna Coil \$1.95.
- Readrite meters \$.95 and up.
- Full line of Pilot parts—lowest prices.
- Speaker relay—one or two speakers at once.
- Full Stock of Amertran
- Genuine Baldwin Type "C" phones, a necessity for short-wave reception, \$3.65 a pair.

**BLAN THE RADIO MAN, Inc.**  
89B Cortlandt St. EST. 1923 New York

# 450 Miles on a Gallon of Gas!

According to a recent article by the president of the world's largest motor research corporation, there is enough energy in a gallon of gasoline if converted 100% in mechanical energy to run a four cylinder car 450 miles.



## NEW GAS SAVING INVENTION ASTONISHES CAR OWNERS

A marvelous device, already installed on thousands of cars, has accomplished wonders in utilizing a portion of this waste energy and is producing mileage tests that seem unbelievable. Not only does it save gasoline, but it also creates more power, gives instant starting, quick pick-up, and eliminates carbonyl.

## FREE SAMPLE and \$100 a Week

To obtain national distribution quickly, men are being appointed everywhere to help supply the tremendous demand. Free samples furnished to workers. Write today to E. Oliver, Pres., for this free sample and big money making offer.

**WHIRLWIND MFG. CO.**

999-41 E. Third St., Milwaukee, Wisc.

# Choice of 1200 Newest RADIO VALUES



SEND for our 1930 catalog. Filled with amazing values in screen grid radios, push pull audio, consoles, kits, parts. All standard makes and guaranteed merchandise.

# FREE

**WESTERN RADIO MFG. CO.**  
124 W. LAKE ST. CHICAGO ILL.

## Just Published!

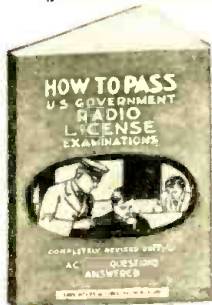

A sure way of passing your Government Examinations!

Here are all the Questions—Completely Answered

IN

# How to Pass U. S. GOVERNMENT Radio License Examinations

By R. L. Duncan and C. E. Drew  
RADIO INSTITUTES OF AMERICA

DON'T take any chances with your examinations. Careful study of this book will insure success in obtaining your Government Radio License, because it contains full particulars, questions and answers, on the latest radio examinations by the government.

It will not only give you all the data, but through the question and answer method used in the text, will teach you how best to express yourself and put that knowledge into words.

259 questions with complete answers show you just what will be expected of you. Order a copy now and start studying!

\$2.00

### On Approval Coupon

John Wiley and Sons, Inc.,  
440 Fourth Avenue, New York.  
Gentlemen: Kindly send me on approval Duncan and Drew's "How to Pass". At the expiration of ten days I agree to remit \$2.00 or return the book postpaid.

Name .....  
Address .....  
Reference ..... R.C. 12-29

## COOPERATIVE RADIO LABORATORY

(Continued from Page 261)

plifier tube where the required bias is in the neighborhood of 6 volts. As usual, the resistor must be by-passed with a heavy condenser; 1-mf. is sufficient, and it need not be a high-voltage expensive unit.

### Shielding the Hybrid's Input

The only shielding that has been found necessary in this hybrid-tube circuit, on A.C. operation, is in the grid circuit of the hybrid tube. The lead from the crystal to the grid of the tube should be as short as possible and, even then, should be protected from external fields by shielding, which should be well grounded. The grid biasing of the "detector" or hybrid tube is a real problem. Fig. 6 shows two sketches—with grid bias (A) and without it (B). In the latter case, there is nothing to worry about. The grid is merely grounded, and so is the cathode. To apply a bias, however, it is best to employ a small separate "C" battery. Such a battery should last at least a year, and it prevents all manner of trouble from hum, which the biasing resistor will introduce into the circuit. You see, the plate current of the hybrid tube is so small that proper value for the resistor can hardly be figured. Operating the detector grid on a cut-off bias, and inserting the 2-megohm resistor in the plate lead, should be sufficient reason for a minute plate current.

With all the "C" biases thus determined, it is now an easy matter to follow the signals through the rest of the circuit. The tuning into the hybrid tube is accomplished in the regular manner. The .015-mf. fixed condenser in this tuned grid circuit is inserted merely to permit the second and third tuning condensers to be ganged. Ganged units usually have common rotors, which force all grids to return to the same point, unless some precaution is taken. This condenser is the precaution. It completes the tuning circuit back to the rotor of the tuning condenser, but prevents the coil from being short-circuited to that point. Hence, the coil can be taken out to any part of the circuit for its proper bias; in this case, the small dry-cell battery.

## SOLVING CITY PROBLEMS

(Continued from Page 265)

The "RFT" or balancing resistor shown in the "RFX" in the schematic circuit is found only in the last "RFX" in the line; all the other "RFXs" on that "riser" are connected to alternate sides of the "riser" and without the use of this center-tapped resistor.

Within twenty feet of the "RFX" is placed the "radio outlet unit" ("RFO"); a snap switch is provided here to control the filament current for its "RFX." (A delicate relay opens the filament circuit of the "RFC" on the roof, when the last "RFX" in the building is no longer being operated.)

It is preferable to install the wiring (an all-conduit job) when a building is being built; for it is then most convenient to place this conduit and all fuses, together with the "RFC," the "RFLs," "RFXs" and the "RFOs."

In one building on 107th Street in New York City, such a system serves the owners

# "Trouble Shooter's Manual"

By JOHN F. RIDER

## Wiring Diagrams of All Well Known Receivers!

Besides 22 chapters covering thoroughly the field of trouble shooting, this volume contains the wiring diagrams of models, as obtained direct from the factory, a wealth of hitherto confidential wiring information released for the first time in the interest of producing better results from receivers. You will find these diagrams alone well worth the price of the book. The wiring diagrams are of new and old models, of receivers and accessories, and as to some of the set manufacturers, all the models they ever produced are shown in wiring diagrams! Here is the list of receivers, etc., diagrams of which are published in this most important and valuable book:

- R. C. A.**  
60, 62, 20, 64, 30, 105, 51, 16, 32, 50, 25 AC, 28 AC, 41, Receptor S.P.U., 17, 18, 33.
- FEDERAL**  
Type F series filament, type E series filament, type D series filament, Model K, Model E.
- ATWATER-KENT**  
10B, 12, 20, 30, 35, 48, 32, 33, 49, 38, 36, 37, 40, 42, 52, 50, 44, 43, 41 power units for 37, 38, 44, 43, 41.
- CROSLY**  
XJ, Trirdyn 3R3, 601, 401, 401A, 608, 704, B and C supply for 704, 704A, 704B, 705, 706.
- STEWART-WARNER**  
300, 305, 310, 315, 320, 525, 500, 520, 525, 700, 705, 710, 715, 720, 530, 535, 750, 801, 802, 806.
- GREBE**  
MU1, MU2, synchrophase 5, synchrophase AC6, synchrophase AC7, Deluxe 428.
- PHILCO**  
Philco-electric, 82, 85.
- KOLSTER**  
4-tube chassis used in 6 tube sets, tuning chassis for 7 tube sets, power amplifier, 7 tube power pack and amplifier, 6 tube power pack and amplifier, 110 volt DC set, 6 tube 110 volt DC set, 6 tube 32 volt DC set.
- ZENITH**  
39, 39A, 392, 392A, 40A, 35PX, 35APX, 352PX, 352APX, 37A, 35P, 352P, 352P, 352AP, 34P, 342P, 33, 34, 35, 35A, 342, 352, 352A, 362, 31, 32, 333, 353A, power supply ZE17, power supply ZE12.
- MAJESTIC**  
70, 70B, 180, power pack 7BP3, 7P6, 7P3 (old wiring) 8P3, 8P6, 7BP6.
- FRESHMAN**  
Masterpiece, equaphase, G, G-60-S power supply, L and LS, Q15, K, K-60-S power supply.
- STROMBERG-CARLSON**  
1A, 2B, 501, 502, 523, 524, 635, 636, 403AA power plant, 404 RA power plant.
- ALL-AMERICAN**  
8 tube electric, 8 tube 80, 83, 84, 85, 86, 86, 6 tube 60, 61, 62, 63, 66, 6 and 8 tube AC power pack.
- DAY FAN**  
OEM7, 4 tube, 5-5 tube 1925 model, Day Fan 8 AC, power supply for 6 tube AC, B power supply 5524 and 5525, motor Generator and filter, 6 tube motor generator set, 6 tube 110 volt DC set, 6 tube 32 volt DC set.

There are also wiring diagrams of Pada, Freed-Eisemann, Colonial, Workrite, Amrad, Spartan and others. Size of Book 8 1/2" x 11"—234 pages. Profusely illustrated with charts and full page diagrams.

## RADIO TREATISE CO. 1440 B'way, N. Y. C.

Send No Money

RADIO TREATISE CO.,  
1440 Broadway,  
New York City.

Send me John F. Rider's "Trouble Shooter's Manual" and I will pay postman \$3.50 plus a few cents for postage on delivery. It is understood that my money will be refunded if I am not entirely satisfied.

Name .....  
Address .....  
City ..... State .....

of approximately thirty different types of radio receivers, including regenerative sets. However, since each "RFX" acts as a blocking tube, there is no interference between receivers and reception is reported to be several hundred per cent better than in a former test when individual aerials were used.

An oddity of design will be observed in the schematic circuit, in the grounding of portions of the circuit requiring connection to "B+". The necessary plate potentials, however, are obtained by this connection; since the "B+" lead from the "B" eliminator is grounded. Instead of following the usual practice of grounding "B—" and insulating "B+," the reverse method was adopted, as shown in the schematic diagram; the insulated "B—" leads are part of the "risers" connecting the "RFC" and the "RFXs." One "B—" lead connects to the grid of each "RFX" tube, and the correct grid bias is obtained by the drop through the resistor R5. (In the same manner grid bias for the '26 tube in the "RFC" is obtained.)

Another conduit, paralleling the first, contains the power line from which the power transformers and switches are tapped off. A separate transformer winding is used for the filament of each tube. Regular "junction boxes," such as are used in regular electric-light wiring, are placed at these connections. One filament transformer is located in each "RFC" and "RFX"; the power transformer, filter-condenser bank, and resistor network are found only in the "RFCs." Because this "B" eliminator is standard, for the sake of clarity it is omitted from the diagram.

Maintenance of such a system as this resolves itself merely into replacing tubes after they have run their normal life.

Complete installations have been designed to operate in direct-current lighting districts, as well as those where A.C. is available.

### DEVELOPMENT OF MODERN SOUND REPRODUCERS

(Continued from Page 268)

about seventy-two phones (as the writer remembers it) in a room with square ends, and length somewhat greater than the height; the only theoretical defect with this scheme, if a parallel-front wave advancing down the audience were produced, would be the production of standing waves and these would be minimized by the mixture of all the notes with their different damping, etc.

It is hardly necessary to point out that low tones produce less interference of the kind described than the higher ones, in average rooms or a small hall. The difference- or "Tartini" tones may be just as had if they are backed by long-sustained components like the "low C" and its "major third." However, all these effects are reduced or destroyed by the presence of fittings, furnishings, tapestry and the listeners themselves in a room.

#### Construction of Diaphragms

We have seen that in a "unilateral" electrostatic loud speaker, like that in Fig. 6, there is in the scale of frequencies a "change-over" point above which the piston action ceases, and the diaphragm vibrates in distinct segments or zones; the smaller the diaphragm, the higher the frequency at which this takes place.

In the "bilateral" reproducer of Fig. 7, the change-over frequency is much higher, and a higher voltage from the amplifier output is required to make this effect noticeable. In

# "N.Y. ELECTRICAL SCHOOL" Men Graduate into many fields...



AVIATION ELECTRICITY

AUTOMOBILE ELECTRICITY

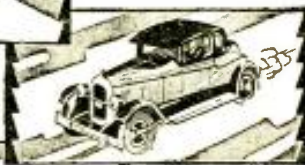

NAUTICAL ELECTRICITY

ELECTRICAL ENGINEERING



A full knowledge of electricity, as taught in the New York Electrical School, makes you independent, gives you your choice of either a **BIG PAY** job with one of the world-famous electrical companies, or a business of your own. **ELECTRICITY** is also a stepping-stone to Aviation, Automobile Engineering and other highly paid professions.

Here at the New York Electrical School you learn, not by correspondence, but by **ACTUAL PRACTICE** on full-size standard equipment. **NO BOOKS** used. Individual instruction—you can start any day. This School owns and occupies two seven-story buildings in New York—the city of most opportunities. It is widely known as the country's oldest and foremost institution for trade training. That's why big companies eagerly demand our graduates.

### THE NEW YORK ELECTRICAL SCHOOL

21 West 17th Street, New York



**FREE**

This big 64-page booklet gives full information about the New York Electrical School courses and picture of the equipment available for your personal use. Send for it TODAY. It's free.

MAIL TODAY

The New York Electrical School  
21 West 17th Street, New York

Please send me **FREE** your 64-page booklet. It is understood that this request puts me under no obligation.

Name .....

Address .....



## Ex Libris Beautiful Bookplates

DO YOU TAKE PRIDE IN YOUR LIBRARY?

A **PERSONAL** bookplate, with your name on it insures you against loss of your cherished volumes. The friend who borrows your book can't fail to be reminded that *it belongs to you!*

A bit of the feeling of the great Old Masters is captured for you in our artistic *Duo-Tone Bookplates*, reproducing old woodcuts and engravings, on antique-tint vellum paper. \$2 up per hundred, your name imprinted. Send 10c for specimen and illustrated catalogue of our unique new series.

**ISKOR PRESS, Inc.**  
286 Fifth Ave. (Dept. 9) New York

# The Most Outstanding Literary Success in the Magazine World

## The Twin Magazines of Scientific Fiction



—the future in aviation . . .  
100, 1,000 and 10,000 years  
hence.

—colorful scientific fiction  
stories by world's foremost  
authors . . .

**H**OURS of pleasant pastime are well spent in reading stories that you like—stories that are educational and entertaining—written by men with a vision of future flying. You will read stories that reach beyond present day aviation methods—future warfare—gravity nullifiers—cities in the air—trips around the world, and gripping revelations to expect of aviation 100, 1,000 and 10,000 years hence.

Each issue of AIR WONDER STORIES gives you the best stories in aeronautical scientific fiction, a test on your knowledge of aviation, aviation news, aviation forum; letters from our readers and book review.

Enlightenment—entertainment—there's a world of it in science fiction, and it's within the grasp of everyone. You will find plenty of both in SCIENCE WONDER STORIES—stories by many of the outstanding writers of scientific literature—authors who have spent years in study to attain literary success in this field. You can share their knowledge of science, and as well, benefit by their contributions to the ever-widening demand for interesting scientific fiction literature.

Just read on to the very last word and learn what each issue of SCIENCE WONDER STORIES gives its readers—stories, science test, science questions and answers, reader's forum and book review.

Each issue of AIR WONDER STORIES and SCIENCE WONDER STORIES contains 100 pages, including full-page illustrations by Paul and other famous artists, and a 4-color cover. Just send in the coupon below with one dollar and you will receive either magazine for eight months. At the newsstands

**25c**  
The Copy

|   |  |
|---|--|
| Regular<br>Subscription<br>Rates<br>\$2.50 in U. S.<br>3.00 in Canada | <b>SPECIAL<br/>OFFER</b><br><b>8 Months For \$1<sup>00</sup></b> |
|---|--|



STELLAR PUBLISHING CORPORATION  
98 Park Place, New York.

Dept. RC-12

Enclosed find \$....., for which enter my subscription for eight months to

Air Wonder Stories       Science Wonder Stories

Name .....

Address .....

City and State .....

both types, the tighter the radial pull on the diaphragm, the better the quality of the reproduction. In the German models a secret aluminum alloy is used for the purpose, in discs a foot in diameter and 1/200 of an inch thick; and separated, about 2/100 of an inch. It is tightened by the use of sixteen movable cones, sliding eccentrically into conical housings spaced around a metal rim toward which the diaphragm is pulled by grip on the foil (Fig. 8). The mechanical pull exerted on the metal foil by these cones is extremely high. Temperature changes, within the room range, do not appreciably loosen it. Copper is too weak, and steel or iron are inferior in performance; but in the absence of the special alloy, experimenters may find it necessary to use copper-coated or otherwise processed steel.

An improvement on the single-diaphragm reproducer has been obtained, as shown in Fig. 9, through dividing it into a number of segments by securing it in its "polarized," or stretched position at rest, so that it is immovable along certain lines—eccentric circles and radii. This is done by the use of a stiff frame. Since the membrane is already convex toward its fixed armature because of the polarizing voltage, the frame must be slightly convex also to fit against it. Furthermore, the diaphragm must be strongly fastened; for, otherwise, every half wave in the audio-frequency cycle will pull it away from the frame, and the segments of the diaphragm will cease to be effective as such. As they are, they have different points of resonance and change-over, so that they do not work together to add distortion. (This is German patent 426,839.)

### Multi-Unit Systems

In this system, which has a number of small diaphragms mechanically independent, we find that the number used, ranges from eight (in "phantom music," using small speakers in series-parallel) up to enormously large numbers. In some modern forms, using "goat-eye" vent-holes, and designed especially to promote piston action, there are 675 sound or air-vents in a mesh-unit, 8 x 12 inches; and as many as 96 units of these are used to form a "speaker" twelve feet square.

In the Reisz electrostatic reproducer, the number is immensely greater; here, as in Fig. 10, we have a dielectric or insulating membrane to which a countless number of granules of conductive graphite are cemented; in a 12-inch speaker there must be millions of them. They are made to form a single conductor by the fact that each is in sliding and rolling contact with those next to it, while it adheres to the insulating membrane only at the bottom. This instrument is the best illustration of a perfectly loose set of pistons developed to date; but, plausible as its advance notices were in 1926, it does not seem to have been a striking success, even in spite of introducing the refinement of spacing the middle of its fixed armature further, from the diaphragm, and thereby permitting the latter to be nearly flat in its vibration over a considerable distance. The design of this speaker is based on extensive experiments, by Hollundermark, on the action of conducting granules between the plates of a condenser; and this type may yet be a competitor of others better known in the United States.

(Part II of this article will go into further detail with the explanation of the latest revolutionary addition to the electrostatic reproducer family—the "goat-eye" or "mesh-unit" type; it will appear in a later issue of RADIO-CRAFT—Editor.)

INFORMATION BUREAU

(Continued from page 270)

Although 1, 2 and the antenna may all be connected together, a refinement, an antenna switch, is indicated in the dotted enclosure.

ZENITH "4R"—RADIOLA "SUPER"—FINDING A.F.T. CURVE—BRISTOL "COMPARAPHONE"

(35) Mr. E. R. Prince, N. Parkersburg, W. Va.  
(Q.) A Zenith receiver "Type 4R" works well on three tubes but not on four. Testing has proved that the third A.F.T. is burned out (Why are there three A.F.T.'s?). I cannot get another transformer

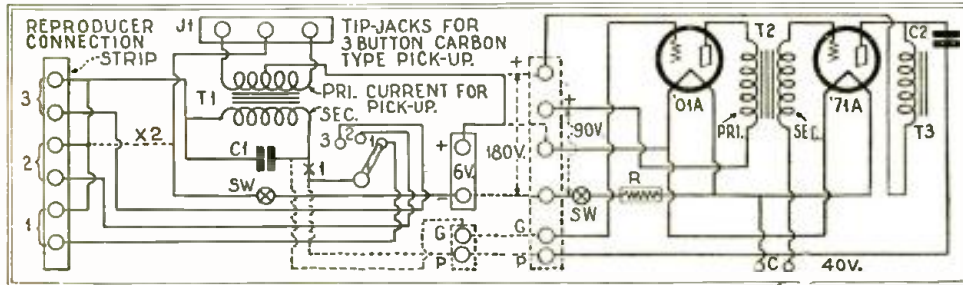

(Q.35) The Bristol "Comparaphone." Means for amplifying the output of this arrangement, thus making it possible to use a "magnet" pick-up, are shown.

to work properly, although remainder of circuit seems to be O.K. Please suggest a remedy.

(A.) Three stages of A.F. amplification were selected to obtain greater volume than could be obtained with only two stages. Your difficulty is due to the fact that all the A.F. transformers so far tried have been of too high a "turns ratio." Use for T3 a transformer with a turns ratio of about two-to-one.

It is suggested that a '12A or 71A tube be used as V4. The necessary changes to use the former are indicated in the diagram; they are the inclusion of special "B" and "C" potentials for this tube, no change being necessary in the filament circuit. The odd location of the added "B" unit is occasioned by the wiring of the "Stage Selector Switch." Resistors R are 1/2-amp. ballasts; L1, L2 and L3 constitute a "3-circuit tuner," L1 being tapped; L2 is tuned by C1; C2 may have a capacity of .0005 to .001-mf. Units R limit the filament potential to 5 volts, while the 30-ohm resistor functions as a master control of the potential below that value.

(Q.) What might cause a "Radiola Superheterodyne" ("Second Harmonic" semi-portable) to appear "dead" at times, operate well for a time, then suddenly go dead?

(A.) This is probably due to loose contact at the "cat" (catacomb). Closely examine all connections on the aluminum "cat"; this is grounded, and voltage tests may be made with one side of the meter grounded against it. A milliammeter in the "B—" lead will fluctuate, if there is a break in the "B" circuit, during the process of shaking the leads of the set; a similar meter in the "A" circuit would check defective "A" connections.

There is a loop built into the rear of this receiver, and it occasionally happens that its connections to the set work loose. Another cause of trouble in

this receiver is poor tube-prong contact. Clean the tube-socket springs with sandpaper, similarly clean the tube prongs; and bend up the socket springs, carefully, by placing below them a piece of cord and pulling it up. Whether the latter performance is necessary, may be determined by gently wiggling each tube; if the receiver suddenly stops operating, this is due to an open circuit which will be remedied by restoring good contact.

(Q.) Please show a schematic circuit for taking the "characteristic curve" of an A.F. transformer, or for determining its comparative value.

(A.) The circuit requested appears in these columns. As shown, it is of value only for obtaining an approximation of the "gain" or voltage step-up of a particular transformer, at 1000 cycles (1 kc.), as compared to another transformer used as a standard. However, the gain of a complete stage, includ-

ing such a transformer, at other frequencies may not be in proportion to this value.

To obtain a true picture, it is necessary to make a graph of the values obtained at other frequencies; this is possible by using an oscillator adjustable to these frequencies.

The constants of T3 will be determined by the design of the oscillator and the characteristics of the tube selected as V1 (the voltages indicated are for an '01A). The milliammeter should read nearly zero, until the oscillator is started.

(Q.) Please advise me as to how a Bristol "Comparaphone" should be connected to eliminate a loud rushing sound when dynamic reproducers are being tested. How could A.F. amplification be added to this unit?

(A.) This instrument was designed to be used with a carbon-type phonograph pick-up; too much battery current or a poor pick-up will result in this rushing sound. The remedy is obvious.

A.F. amplification may be added, in the manner indicated, in the schematic circuit which appears in these columns.

As T1 has a low-resistance primary, designed for a carbon-type pick-up, it may be necessary to change this unit to obtain the desired primary impedance if a magnetic-type pick-up is used.

The circuit changes required to add A.F. amplification are as follows: break lead at X1 and run two leads, G and P, to the terminal strip indicated in dotted lines. Run dotted connection X2. Wire the audio amplifier, following any desired arrangement of parts, and connect its terminal strip to the "Comparator" as shown; R is a two-tube filament ballast; C1 has a capacity of about .0005-mf. If a magnetic pick-up is used, the center tip-jack may be disregarded.

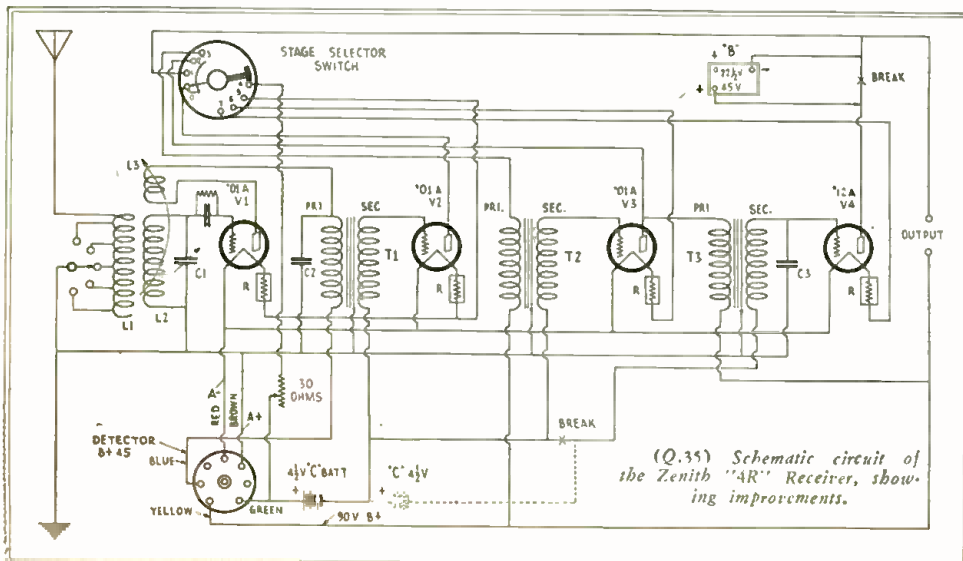

(Q.35) Schematic circuit of the Zenith "4R" Receiver, showing improvements.

Makes Any Tube Last LONGER and Perform BETTER

By automatically keeping voltage exactly right for each tube, AMPERITE lengthens tube life and improves reception. Never wears out. Insist on AMPERITE. A type for every tube—A.C. or D.C. \$1.10 with mounting (in U. S. A.) At all dealers.



**CORWICO**  
**VULCAN**  
**Lightning Arrester**  
**\$1**

**\$100 Guarantee Against Lightning Damage**  
Enclosed in Each Box. It Also Dissipates Accumulated Static Charges.  
At Your Dealer or Direct  
**CORNISH WIRE COMPANY**  
36 Church Street, New York City  
Makers of Corwico BRAIDITE Hook-Up Wire

**Make Your VEST POCKET Bring You \$95 a Week**

**CARRY** this amazing new adding machine in your vest pocket. Make \$3.00 an hour showing it to storekeepers, bookkeepers, professional men and others. Agents cleaning up with this fast seller. Everyone who does any kind of figuring needs it and will buy on sight.

**Complete Adding Machine Only \$2.95**  
VE-PO-AD duplicates work of large adding machines. Sells for only \$2.95. Adds, subtracts, multiplies—in a jiffy. Always accurate—never gets out of order. Over 200,000 in use. You make 100% profit on every sale. Man! If you ever had a chance to CLEAN UP BIG MONEY—here it is!

**FREE Sample**  
**Sample Ve-Po-Ad FREE**  
You don't need experience. Shapiro made \$175 his first week. Others make \$50 to \$100 a week regularly. You can sell as many as 3 Ve-Po-Ads an hour—over \$4.00 clear profit for you. Grasp this quickly! Write at once for full details of FREE Ve-Po-Ad offer and my MONEY-MAKING PLAN. Do it NOW.

**C. M. CLEARY**  
303 W. Monroe St. Dept. 5-A Chicago, Ill.

WHEN it comes to making sick radios well, or good radios better just

Remember **CLAROSTAT** for Every Purpose

For literature, write CLAROSTAT Mfg. Co.  
295 N. 6th St., Brooklyn, N. Y.

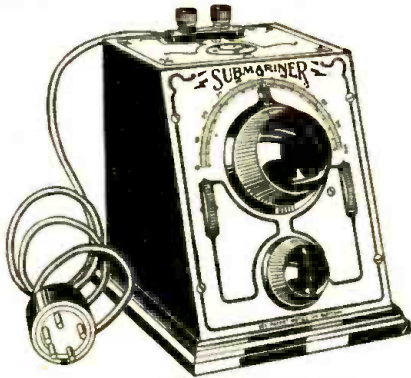

**SHORT WAVES  
THE SUBMARINER**

will convert your receiver into a short wave receiver without any changes.

Enthusiastic owners have written us from all parts of the world. Stations broadcasting music 8000 miles away have been received. Very little static on short waves. Latest improvements—shielded—vernier dial 64 to 1 ratio—a quality product—on the market over three years.

**Many Models**

16-32 meters, AC or DC, \$17.50. Interchangeable coil, 12-160 meters, AC or DC, \$22.50. "J" model gives five times volume of other adapters. Price, 16-32 meters, \$22.50. Interchangeable coil "J" model, \$27.50. Sent postpaid upon receipt of price or C.O.D. if \$1.00 accompanies order. Give name of set and tubes used, when ordering.

**J-M-P MFG. CO., Inc.**

3333 Fond du Lac Ave., Milwaukee, Wisconsin.

**TO NEW READERS**

A few copies of the July, August, September, October and November issues of

**RADIO-CRAFT**

can still be had at the regular price of 25c each. Send stamps, cash or money order to:

**RADIO-CRAFT**

98 Park Place New York, N. Y.

**MAKE  
GOOD RECEPTION  
EASY**

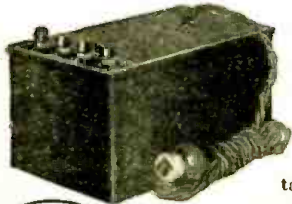

Thousands of users marvel at the difference in reception with a Townsend "B" Power Unit. Full, sweet tone, clarity, volume and greater distance are among the many advantages reported daily.

**TOWNSEND  
"B" POWER UNIT**

Hooked up in a few minutes; just plug into the light socket and forget it. Delivers up to 100 volts on any set—D.C. or A.C.—any cycle.

Approved and passed by the rigid laboratory tests of "Popular Radio" and "Radio News."

**Over 150,000 Now in Use!**

There's no longer any reason for putting up with the expense and un dependable performance of "B" Batteries—when you can own a good "B" Power Unit for \$6.85. Over 150,000 Townsend "B" Power Units now in use—a substantial proof of satisfaction.

**Send Only \$1.00**

Send name and address with only \$1.00. On arrival of Townsend Power Unit pay postman \$5.85 plus postage. Try out ten days, then, if it fails to do everything we say, return it and money paid us will be refunded. Make a REAL receiver of your set.

**TOWNSEND LABORATORIES**

723 Townsend St. Chicago, Ill.

**HAS ONLY  
WORDS OF  
PRAISE**

Please send me another Eliminator. I have had one of your Eliminators in constant use on a 5 tube set for over two years and have only words of great praise for it. An accident with it is my reason for wanting another.

J. Cassidy,  
531 Sterling Place,  
Brooklyn, N. Y.

**LETTERS FROM READERS**

(Continued from page 262)

the end of my condenser shaft, to try to keep the set automatically below the point of oscillation; and I am sure it can be done with the proper value of resistor. My next experiment will be a tuned stage ahead of the detector. I find that by-pass condensers in the proper parts of the circuit make a vast improvement in distant reception.

I certainly believe that the coming popular set will have fewer tubes than those used today; as a few tubes will do plenty of work if the proper hook-up is found.

The greatest difficulty has been in finding the perfect variable condenser. A change of condensers will bring in stations, but lose others, while using the same coil for both. I make a constant study of condensers and coils and absorb everything I see published on that subject.

I have secured my best results with all-battery operation. Line-voltage fluctuation is bad in this district, and sets "bloop" too easily. Eventually, I suppose, some means of good control of voltage, automatically, will overcome that difficulty. If you know of any at present, make mention of it in some of your issues.

Keep up the good work on RADIO-CRAFT, and I am sure that, when any of the fellows get hold of your magazine, they will become steady subscribers.

**F. P. CORRIGAN,**

Rutherford Garage, Rutherford, Calif.

(Mr. Corrigan is typical of a great many experimenters who still enjoy working things out for themselves. The dial-nurser will get things out of three tubes that escape from the owner of a commercial seven- or eight-tube who knows only that there is a switch marked "On" and "Off." We cannot see why there should be "holes" in the operation of any good condenser if the plates are in good shape and rigid on their mountings, and there is no back-lash or lost motion in the dial. There are numerous automatic voltage regulators on the market, some of which have been described in our "New Things" pages; and others will appear later. Some are automatic transformers, which permit only a certain voltage to exist between the secondary ends; others are variable resistors—such as the regulator tubes—which take an input exceeding the needs of the set, and dissipate all but the proper amount of energy.—Editor.)

**SHORT-WAVE STATIONS HEARD**

Editor, RADIO-CRAFT:

FW4, St. Assise, France, is working on 15.55 meters to Buenos Aires and 24.5 meters to Saigon, Indo-China, from 1 to 3:30 p. m. E. S. T. Friday, Saturday and Sunday. The power is 15 kw. DHC of Nauen, Germany, with the same power, is heard working the same stations sometimes, mainly Thursday, Friday, Saturday and Sunday, on 26.22 meters.

On the night of July 26, I heard a powerful German station about 45 meters; they gave time at 10:38 p. m. DGW on 14.837 meters is testing around 7:30 a. m., E. S. T.

There is a station VPD at Samoa, Fiji Islands, on a wave of 20 and 30 meters. Nothing definite has been received as to the correct wave, power or transmission schedules yet.

**RICHARD BOGERT,**

1416 Linden St., Allentown, Penna.

(VPD indicates a British colony; Samoa and the Fiji Islands are quite distinct.—Editor)

**NEW MEXICAN STATION?**

Editor, RADIO-CRAFT:

Another new one is XPR or XKR in Mexico; wavelength about 15 meters. This is a German transmitter testing with Nauen and Doberitz between 12:30 a. m. and 2:30 p. m. Eastern Time. All announcing is done in German. I would like to hear from anyone who knows something definite about this station. He has powerful volume and clarity, with little fading; though there is at times powerful telegraphic interference.

**MERLE A. HEATH,**

501 Oak Ave., Waterloo, Iowa.

**ANOTHER GUESS**

Editor, RADIO-CRAFT:

I am working my short-wave set with a "B" power unit (I have tried several makes) and I always have used one. If any of your readers say they can't play their set with one, I invite them to bring it here and I'll play it, and they won't know the difference from batteries. I can also work this set with the charger on, which I can't do on my broadcast set. I have no shielding, nor do I use

**A  
Special  
Courtesy  
to all**

- Radiotricians**
- Professionals**
- Engineers**
- Mechanics**
- Consultants**
- Designers**
- Service Men**
- Contractors**
- Manufacturers**
- Dealers**

In order to make it possible for all Radio Technicians to read RADIO-CRAFT regularly, each month, we have put into effect a special subscription price.

The regular price of RADIO-CRAFT is \$2.50 per year (12 issues). The newsstand rate is 25 cents a copy.

Any radio professional, sending in a subscription on his letterhead, showing that he is engaged in some capacity in radio work will receive as a special courtesy

Eight Issues of



for One Dollar

Just pin a dollar bill to the coupon below and forward it with your letterhead or business card.

**RADIO-CRAFT,**  
RC-12, 98 Park Place,  
New York, N. Y.

Enclosed find \$1.00 for which please enter my subscription to RADIO-CRAFT for eight months.

Name .....

Address .....

City ..... State .....





# SEND FOR THIS NEW RADIO GUIDE!

## IT'S FREE

### Sensational Radio Bargains

DO YOU want to get some of the biggest radio bargains of the year? Then send for this Big Radio Guide and save more money on everything you need in radio sets, parts, short wave apparatus, and supplies. Many new radio wrinkles, never before shown, are fully described and illustrated. A regular radio encyclopedia of information, with full descriptions, illustrations and instructions. Many new lines of supplies offered at startling low prices and big savings to you. One of the most valuable books for the radio fan, set builder and experimenter.

### What's New In Radio

Do you want to know what's new in radio? Read about it in the Barawik Radio Guide. Do you want the latest on Screen-Grid, short wave, all-wave? Barawik's Radio Guide has it. Are you interested in remote control devices, radio-phonograph combinations, public address systems for theatres, etc? Get the facts from Barawik's Radio Guide.

### THIS IS YOUR OPPORTUNITY TO MAKE MORE MONEY

More radio equipment will be sold this season than ever before. Radio dealers, set builders and service men will reap a rich harvest. You have the opportunity now of making big sales and larger profits by making Barawik your radio headquarters. In this way you will make the most of this season by being able to offer a greater variety in sets, furniture, speakers, accessories, parts, tubes and the many necessary appliances needed for perfect radio equipment.

### New, Improved Shield-Grid Sets A-C and D-C

Our line of radio sets this year is better than ever. It offers you a greater variety to meet every sales need, from highest priced quality sets to low-priced popular models, both electrically operated and battery operated. We do not believe any other line on the market offers you so much real dollar-for-dollar value. The performance of these sets is astonishing from the standpoint of pure tone, selectivity, distance and quiet, dependable operation. Selling direct from the factory, as we do, we are able to give you lowest, rock-bottom prices and exceptional bargains.

Buying at our low prices, you can undersell others and give your customers better value for their money.

New sets will sell in big volume this year. More new sets will be bought than ever before, and more old sets will be replaced. Think of the opportunity you have before you to cash in on this demand. Be sure to take advantage of it by featuring our improved lines of factory-built sets, as well as custom-built kits. Our Big Radio Catalog shows the entire line of sets. Send for it now and learn about the special cooperation rendered to our customers.

### Everything You Need is Here All Under One Roof

Why shop around at several different places, when at Barawik's you can get everything you need in sets, parts, short-wave apparatus, accessories and supplies? It saves you time and money to deal with this big institution. We pay the freight on orders of \$50.00 or more, thus giving you a further saving. You can order everything you want, by mail, without talking to salesmen or wasting time. You get a bigger variety from which to choose; you get everything from one reliable house. Our central location insures you fast service on your orders.

### Other Lines to Swell Your Profits

Besides a complete radio line, Barawik offers its customers a tremendous variety of other merchandise that goes well with radio and swells your profits. Such items as electrical appliances, lamps, electrical wiring material, electrical clocks, fans, curling irons, hair dryers, heaters, bulbs, fixtures, stoves, percolators, washers and hundreds of other ready sellers, are included. Then there are sporting goods, auto supplies, tires, tubes, phonographs, etc.

### Service to All Parts of the Globe

Everywhere in the world, Barawik service is making it easier for the radio fan to get the newest things in radio at the lowest prices, besides hundreds of other useful things for the home, auto, workshop and office. China, South America, the Orient, Europe, Australia and Africa are some of the far-off places where Barawik's helpful service reaches. From every state in the Union, from Canada and Mexico, Cuba and the Philippines, Barawik customers send us friendly letters praising our square dealing, our big variety of merchandise, and our very fast service and low prices.

This is the kind of service that will please you, too.

### Send for Newest Radio Guide Now It is Free—Mail the Coupon

Get the full benefit of Barawik's Big Radio Guide in solving your radio problems and purchases. Send for your copy now. It is free.

Simply fill out the coupon, mail it to us, and you will soon be enjoying the same helpful, warm, friendly service that thousands of other radio fans have enjoyed since the pioneer days in Radio.



**MAIL THIS COUPON FOR FREE COPY**

BARAWIK CO., 341-A Canal Station, Chicago, U. S. A.  
You may send me, free, the big new Radio Guide, set-builder's encyclopedia and catalog of newest radio sets, kits, parts, supplies and home accessories, showing illustrations, descriptions and giving me advantage of new low prices.

Name .....

Address .....

City .....

State .....

*The Barawik Co.*  
341-A Canal Station,  
Chicago, U. S. A.

**R. T. I.**

**R. T. I. QUALIFIES YOU TO MAKE MONEY AND ITS SERVICE KEEPS YOU UP-TO-THE-MINUTE ON THE NEWEST DEVELOPMENTS IN RADIO, TELEVISION, AND TALKING PICTURES**

**R. T. I.**

# RADIO CALLS FOR MORE TRAINED MEN

Big Money quick—the chance to more than double your salary—is offered to you now. RADIO has leaped from the experimental stage to a gigantic industry, employing many, many thousands and loudly calling for MORE TRAINED MEN to fill the Big-Pay jobs.

TALKING PICTURES have taken the larger cities by storm and will sweep the entire country, opening up many new good jobs everywhere. TELEVISION now comes with even greater promise of a large number of good paying jobs and big profits for those who are prepared.

### Big Money Now! More to Come

Here is an entirely new field of profitable employment—Big-Money Jobs—\$2500—\$3500—\$5000 and up, right now—lots of money easily made in spare time—increasing pay for you and more and more money as this new industry grows bigger and bigger.



**Let F. H. Schnell and R. T. I. Advisory Board Help You**

Mr. Schnell, Chief of the R. T. I. Staff, is one of the ablest and best known radio men in America. He has twenty years of Radio experience. First to establish two way amateur communication with Europe. Former Traffic Manager of American Radio Relay League, Lieutenant Commander of the U. S. N. R. Inventor and designer of Radio apparatus. Consultant Engineer to large Radio manufacturers. Assisting him is the R. T. I. Advisory Board, composed of men prominent in the Radio Industry.

### Answer the Call—Get Into This Money-Making Industry Now!

The "R. T. I." famous "3 in 1" Home Training in Radio, Television and Talking Pictures makes it easy for men, young men and boys to get into this new field quickly. R. T. I. home training is practical and easy to understand. It trains your head and hands at the same time. Your opportunities for money-making are unlimited. Your age, amount of education, or experience make no difference. If you are interested and ambitious you can succeed. Are you willing to use a little spare time at home? That is all you need to quickly start making money with R. T. I. material and home training. You will be ready for a good job or profitable business of your own, even before you finish the training. Remember—you learn at home in your spare time on actual equipment included in fine, big outfits sent you by R. T. I. R. T. I. with all its connections in the industry, keeps you up-to-date and pushing forward all the time.

### R. T. I. Wonderful Free Book Nothing Like It Ever Published

No one can fully realize the amazing size and future growth of the Radio, Television, and Talking Picture industries unless they know all the facts revealed in this R. T. I. book. No exaggeration is necessary—the plain truth is astounding. It will open your eyes to the dawn of the greatest development in the history of the world—the vast number of new money-making jobs—enormous spare-time profits—all within easy reach of ambitious men. Send for your copy before this edition is exhausted.

**Big R. T. I. Book Free—While They Last**



### Is Now Radio Engineer Through R. T. I. Training

Today I am able to class myself as a Radio Engineer along with the leaders, and this is all due to the help of R. T. I. I have been able to handle intelligently every radio problem with which I have come in contact. I cannot say too much in praise of R. T. I. and any man desiring to improve himself do nothing better than find out what this institution has to offer, and get started with their training.—H. E. SYRENFELD, Chief Radio Engineer, Western Air Express, Amarillo, Texas.

**RADIO & TELEVISION INSTITUTE  
Dept. 779 4806 St. Anthony Ct., Chicago**



**\$500 in 2 Months Hasn't Finished the Course**  
Your radio course enabled me to earn over \$500 in two months spare time work.—J. Nofsinger, R. I. Box 37, Greenville, Ky.



**\$80 a Week—Through R. T. I. Training**  
I am earning \$80 per week and another \$20 a week in spare time Radio Work. Your Course was the best investment I ever made.—W. W. Mead, 915 W. 28th St., Indianapolis, Ind.



**RADIO & TELEVISION INSTITUTE  
Dept. 779 4806 St. Anthony Court, Chicago**

Send me Free and prepaid your BIG BOOK "Tune In On Big Pay" and full details of your three-in-one Home Training (without obligating me in any way).

Name .....

Address .....

City.....State.....

**STEP UP QUICK TO A BIG MONEY JOB THROUGH R. T. I. training in Broadcasting, Sales, Service, Manufacturing, Repairing, Ship and Station Operating, Installing, in business for yourself.**

**R. T. I. R. T. I. TRAINS YOU AT HOME FOR A GOOD JOB OR A PROFITABLE PART TIME OR FULL TIME BUSINESS OF YOUR OWN**

# \$34.50

## SCREEN GRID CHASSIS

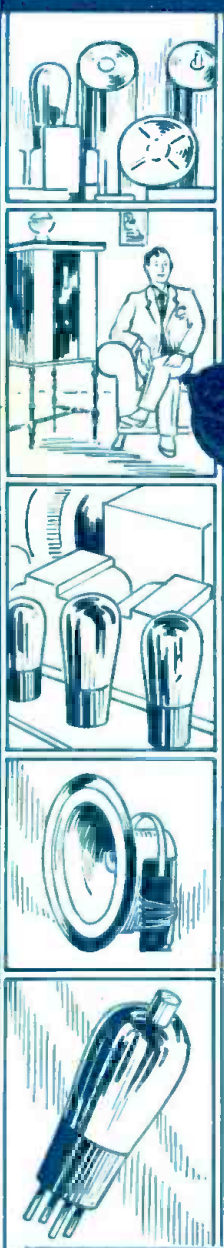

**FREE**  
*Radio Catalog*



**A** POWERFUL super-sensitive A. C. receiver that answers today's demand for the ultra-modern in a high-grade screen grid receiver. It offers everything you look for that is modern in radio. Nothing has been overlooked to secure outstanding quality—advanced engineering features—or efficient performance.

It is establishing a new standard of perfection in radio design. Incorporating such advanced features as screen grid R. F., power detector, "245" push-pull power audio, dynamic tone quality plus practical scientifically shielded construction, it is blazing a new trail in perfection of circuit design. Its super power assures unusual distance range—its ultra-selectivity adapts it for use in the most congested broadcasting districts. Its remarkable tone quality and tremendous volume win for it the instant admiration of the radio purchaser.

**Write Today** for this new 196-page catalog full of all the latest in radio showing the new, humless, Screen Grid A. C. all-electric and battery operated sets. Beautiful consoles, dynamic speakers, accessories, parts, kits; in fact, everything in radio and all at rock-bottom wholesale prices. Hundreds of real radio bargains from a Radio House backed by over \$3,000,000 in resources. This book will save you money. Send for it now before you buy anything more in radio supplies!

*Use the Coupon*

**ALLIED RADIO CORPORATION**  
711 W. Lake St. Dept. 1-4 Chicago, Ill.

Allied Radio Corporation,  
Dept. 1-4  
711 W. Lake Street, Chicago, Ill.

Please send me your new 1930—196-page radio catalog—which we understand is to be absolutely free.

Name.....  
Address.....  
City..... State.....